

## Highlights:

---

- 2" full range aluminum driver
- SlimLine™ grill with 1mm thin border
- Gold-Con™ spring clamps
- QuickFix installation system

## Product information:

---

The MERO speakers will blend beautifully into any interior due to their nearly invisible design making only their extraordinary sound draw your attention. Their slim grill with very thin border of only 1 mm and limited grill depth extrudes the surface by only 3.2 mm when installed. The Ultra-compact size enables the MERO2 smoothly integrate into any interior like no other loudspeaker. The outer dimensions only measure only 146 x 98 mm and the built-in depth which doesn't exceed 70 mm allows installation in any surface while being unobtrusive. The sound originates from a 2" aluminum cone driver which provides a full-range, warm and detailed sound, with an improved response in the low frequencies due to a ported enclosure with closed back can. This way, a smooth sound reproduction with clear and crisp sound is guaranteed. An internal self-resetting network provides an optimal overload protection. All these details share their part to the quality of the MERO 2, resulting in a highly reliable loudspeaker producing a pure sound with a maximum power handling of 20 Watt and an RMS power handling of 10 Watt. An elegant look with minimal visual impact is created by the slim grill with very thin border, while lifetime stability, secure mounting and easy installation is guaranteed using the quick-fix mechanism which can be tightened by two screws and the Gold-Con™ spring clamp connectors. The grill is held in place using neodymium magnets, providing a quick and reliable assembly. Installation can be done both vertically and horizontally.

## Applications:

---

- Hotels
- Corporate
- Residential
- Bars & Restaurants
- Retail

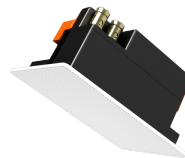

## Impedance:

---

Ω 8 Ohm Ω 16 Ohm

## System specifications:

Speaker type		Full range
Peak power handling		40 W
Program power handling		20 W
RMS/AES power handling		10 W
Impedance		8 $\Omega$ (MERO2)
		16 $\Omega$ (MERO2D)
Sensitivity (1W/1m)		83 dB
Sound Pressure (Max. W/1m)		93 dB
Frequency	Response ( $\pm$ 3 dB)	120 Hz - 20 kHz
	Range (-10 dB)	100 Hz - 20 kHz
Dispersion	Horizontal	165°
	Vertical	165°
Connectors		Gold-Con™ spring clamps
Drivers		2" Aluminium membrane

## Product Features:

Dimensions		146 x 98 x 70 mm (W x H x D)
Weight		0.355 kg
Construction		ABS
Front finish		Thin edged white grill (RAL9003)
Cut-out measurement		128 x 80 mm
Built-in depth		70 mm
Mounting & handling		2 Screw quick-fixing mechanism
Operating temperature		-20 °C ~ 60 °C
Colours		Black frame & white grill
Accessories	Included	Cut-out template
	Optional	WTR06 - 6W 100V line transformer
		GLM02/B - Black grill (RAL9005)
		GLM02/P - Paintable grill
		WMM20 - In-wall box for MERO2
	Included	GLM02/W - White grill (RAL9003)

## Variants:

---

- MERO2I/W - White version - 8Ω (RAL9016 + Logo)
- MERO2 - White version - 8Ω
- MERO2D - White version - 16Ω

## Shipping & Ordering:

---

Packaging	Cardboard box
Shipping weight & volume	0.500 kg - 0.002 Cbm

## Architects' and Engineers' Specifications:

---

The in-wall loudspeaker shall be a full range type fitted in a closed ported enclosure and equipped with a 2" aluminium cone driver with neodymium magnet. It shall have an RMS power handling of 10 Watt with a maximum power handling of 20 Watt and the frequency response ( $\pm 3$  dB) shall range from 120 Hz to 20 kHz. The sensitivity shall be 83 dB when measuring with an input signal of 1 Watt at a distance of 1 meter, while the maximum continuous sound pressure level shall be 93 dB. The nominal dispersion shall be a 165° conical coverage pattern at -6dB (average 100 Hz - 10 kHz). The loudspeaker shall have an impedance of 8 Ohm and shall contain an internal self-resetting network which provides an optimal overload protection. The speakers construction shall be made out of high-quality ABS with a black colour and textured matt surface finishing. A 2-screw quick-fixing mechanism shall allow assembly of the speaker into a ceiling in a quick and simple way while the connectivities are performed using Gold-Con™ spring clamp connectors. To make the loudspeaker nearly invisible when mounted, the speaker shall have a white grill (RAL9003) with a very thin border of 1 mm which extrudes the ceiling surface by only 3.2 mm. This grill shall be constructed of steel which can be painted to make it blend-in with any environment. The assembly and disassembly of the grill shall be very simple thanks to the neodymium magnets holding it in place. The speaker shall have a width of 98 mm, a height of 146 mm and a depth of 70 mm and shall not exceed 0.335 kg. The speaker shall fit in a mounting hole of 128 mm x 80 mm and a build-in depth of 70 mm.

# Acoustical data graphs:

Polars:

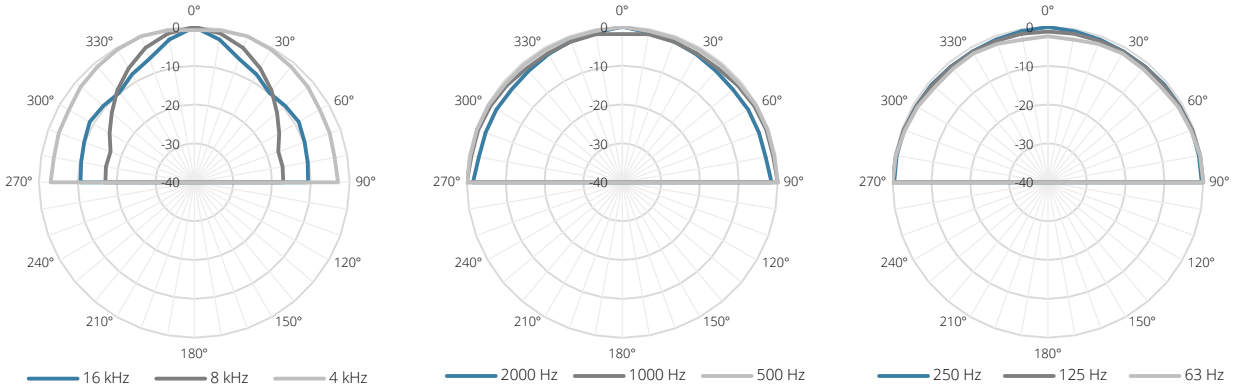

Sensitivity:

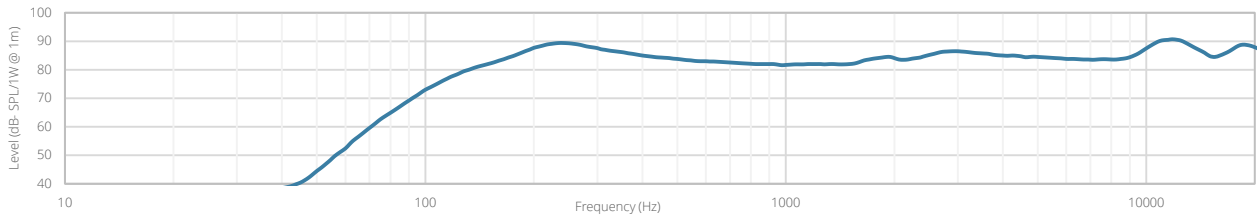

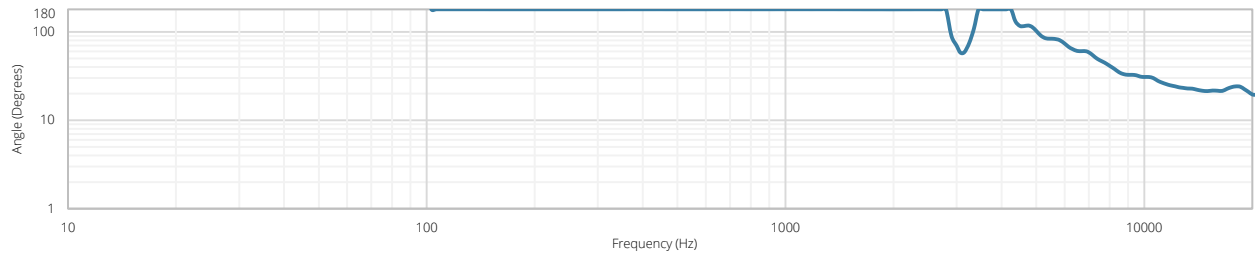

Beamwidth (-3dB):

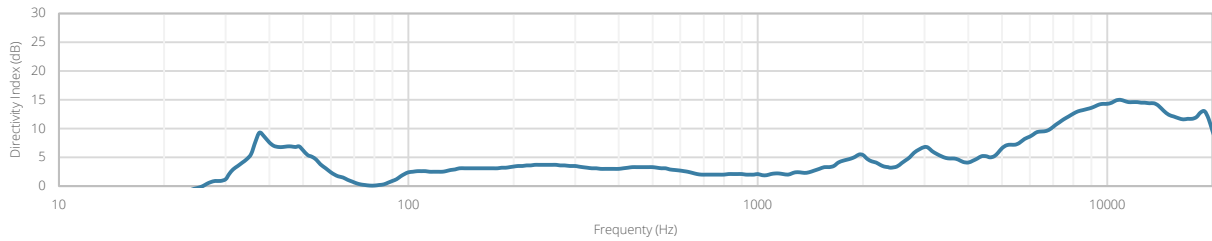

Directivity index:

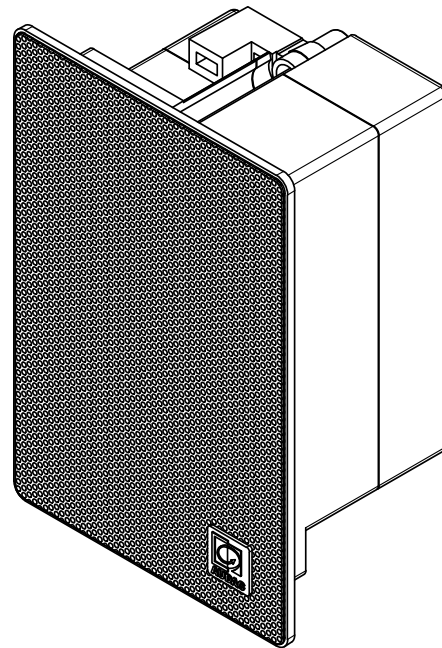
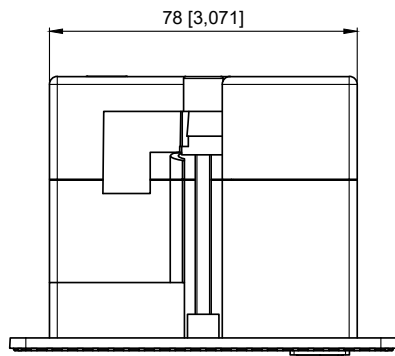
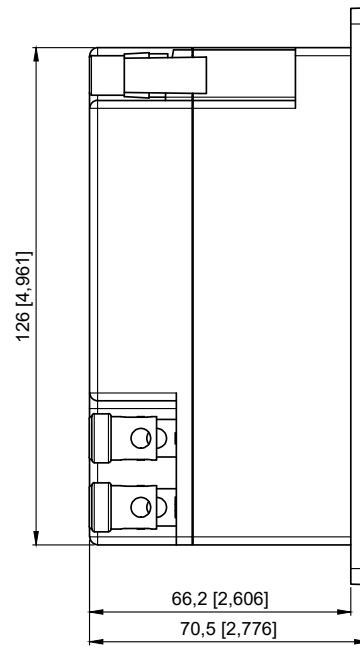
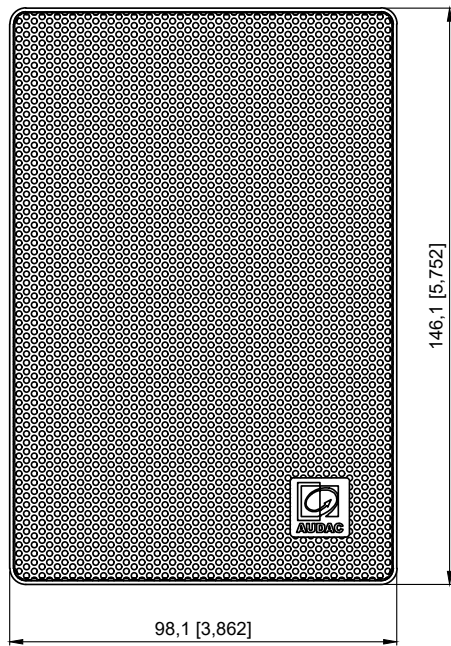



	<b>MERO21</b>		<b>Product description</b> HIGH-END RECTANGULAR SLIM IN-WALL SPEAKER - 2" - 10W		
	<b>MM</b> [INCH]	<b>Scale</b> 3 : 5	<b>Outer dimensions</b> (w x h x d) 98,1 x 146,1 x 70,5 mm 3,862 x 5,752 x 2,776 "	<b>Unit height</b> N/A	<b>Weight</b> 0,35 kg 0,772 lbs