

CANNON C5

HIGH FIDELITY COAXIAL SPEAKER ENCLOSURE



FEATURES

- 5" + 1" Coaxial Transducer
- 5" Passive Radiator
- Bass Response Down to 65 Hz
- 85° Conical Coverage Pattern
- 2-Circuit Input Selector Switch
- IP55 + Salt Water Resistant

APPLICATIONS

- Restaurants
- Monitors
- Front Fills
- Outdoor Systems

DESCRIPTION

The C5 is a unique point source, coaxial loudspeaker. Each Cannon model utilizes a low frequency driver with a coaxially mounted 1" silk dome high frequency driver. The Cannons' silk dome driver is a purpose-built, ferrofluid-cooled design that enables high sound pressure levels, with improved sound quality, as well as consistency and durability over time. The enclosure also incorporates a rear-facing passive radiator specifically tuned to extend the bass frequency response. These key features allow the C5 to provide the sound quality of a studio monitor.

The C5 has two Speakon connectors and a 2-circuit switch, which allows for a choice between two different amplified signals via a single, 4-conductor cable. The C5 is also available in the passive C5i installation version, which features a screw terminal block connector, as well as the passive C5m version with a marine grade cable gland and all stainless steel 316 metal parts.

SPECIFICATIONS

Audio Specifications

- Description:** Passive 5" coaxial with a 5" passive radiator
- Bandwidth:** 65 Hz - 18 kHz (-6 dB)
- Max SPL:** 113 dB SPL @ 1 m w/ preset
- Power:** 240 watts (continuous), 120 watts (AES)
- Directivity:** 85° conical
- Elements:** (1) 5" coaxial with a 1" dome high frequency element, (1) 5" passive radiator
- Impedance:** 16 Ω
- Connectors:** (2) NL4, 1+1- (circuit 1), 2+2- (circuit 2) with input selector switch

Mechanical Specifications

- IP Rating:** IP55 indoor/outdoor and salt water resistant
- Rigging:** (4) M6 points
- Weight:** 9.4 lb / 4.3 kg
- Construction:** Finland birch plywood (phenolic resin), three coats of polyurea, matte salt and UV resistant coating, A4 (316) stainless steel hardware, galvanized and powder-coated black or white steel input plate, 3D spacer mesh fabric
- Dimensions:** 7.5" (190 mm) x 7.5" (190 mm) x 8.2" (208 mm)
- Colors:** Stocking black and white, custom colors and fabrics available
- Accessories:** C-Clamp (wall-, truss-, mic stand- or ceiling-mount), Universal Mounting Plate, Pole Mount Adaptor, L-Bracket, Tube Mount, Swivel Mount

DIRECTIVITY

Horizontal Polar Plot LF

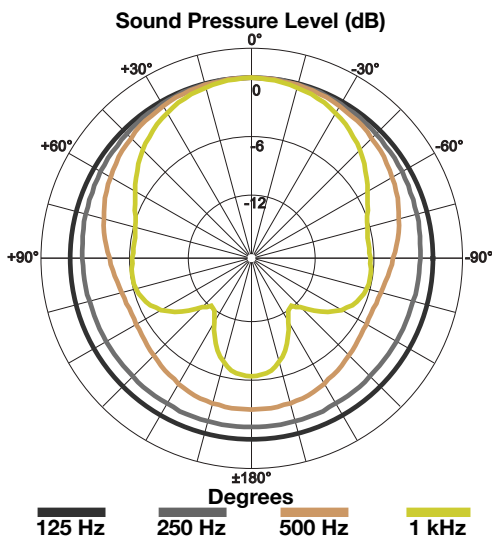

Horizontal Polar Plot HF

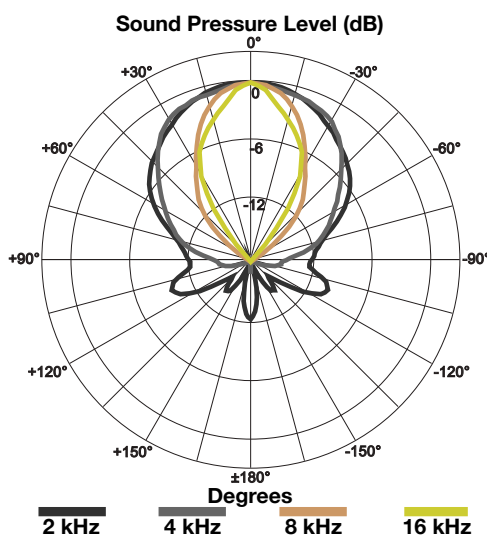

Horizontal

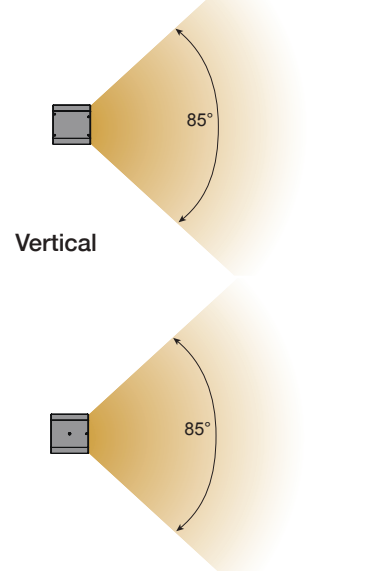

FREQUENCY RESPONSE

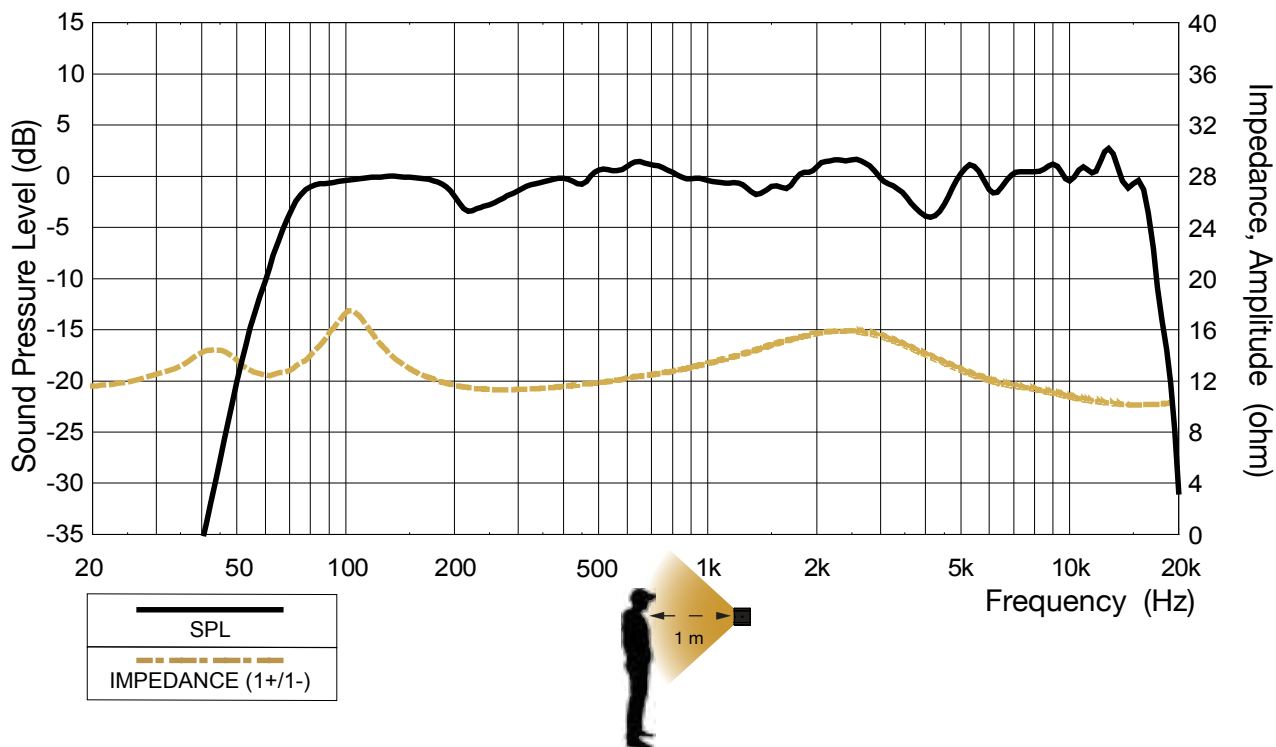

WIRING

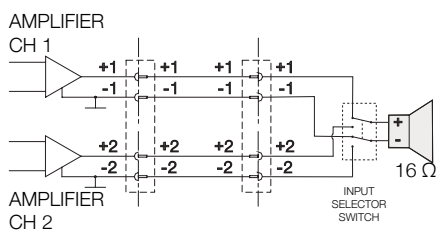

(simplified)

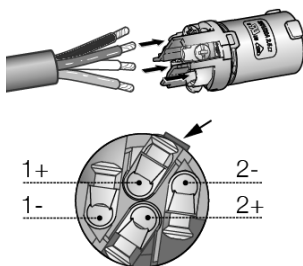

NL4 input/output wiring

Pinout:
 Circuit 1:
 1+ Positive full range
 1- Negative full range
 Circuit 2:
 2+ Positive full range
 2- Negative full range

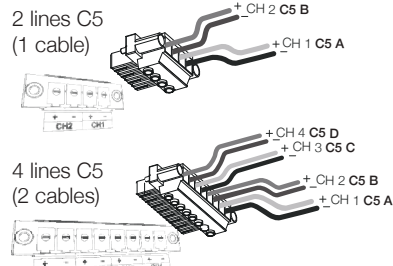

Euroblock 4/8-p amplifier output wiring

DIMENSIONS

RIGGING

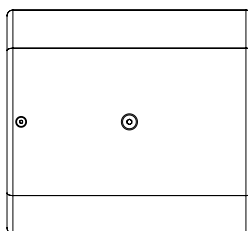
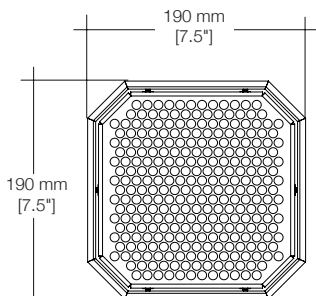
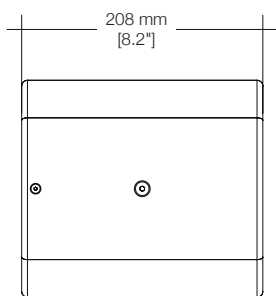

side

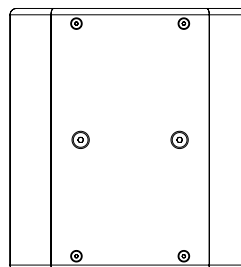

bottom

(4) points M6
 • Bottom: (2) points M6 – for mounting plate and pole mount
 • Sides: (2) points M6 – 1 each side for C-Clamp

ACCESSORIES



Contact

For more product or service information please contact the 1 SOUND headquarters.

1 SOUND, Manufacturer
 USA Distributor
 34 Apple Street
 Tinton Falls, NJ 07724

tel. +1-732-798-9900
 sales@1-sound.com

Warranty

All manufactured 1 SOUND products are warranted to be free from defects in materials or workmanship for a period of 3 years from original purchase. If there is specific hardware or grilles you might want replaced or any repairs needed please contact your region's authorized 1 SOUND distributor.



CANNON C5i

HIGH FIDELITY COAXIAL INSTALLATION SPEAKER ENCLOSURE



FEATURES

- 5" + 1" Coaxial Transducer
- 5" Passive Radiator
- Bass Response Down to 65 Hz
- 85° Conical Coverage Pattern
- High Fidelity
- IP55 + Salt Water Resistant

APPLICATIONS

- Restaurants
- Retail
- Offices
- Monitors
- Front Fills

DESCRIPTION

The C5 is a unique point source, coaxial loudspeaker. Each Cannon model utilizes a low frequency driver with a coaxially mounted 1" silk dome high frequency driver. The Cannons' silk dome driver is a purpose-built, ferrofluid-cooled design that enables high sound pressure levels, with improved sound quality, as well as consistency and durability over time. The enclosure also incorporates a rear-facing passive radiator specifically tuned to extend the bass frequency response. These key features allow the C5 to provide the sound quality of a studio monitor.

The C5i features a screw terminal block connector, with parallel link output. The C5i is also available in the C5 version, which has two Speakon connectors and a 2-circuit input selector switch, as well as the passive C5m version with a marine grade cable gland and all stainless steel 316 metal parts.

SPECIFICATIONS

Audio Specifications

- Description:** Passive 5" coaxial with a 5" passive radiator
- Bandwidth:** 65 Hz - 18 kHz (-6 dB)
- Max SPL:** 113 dB SPL @ 1 m w/ preset
- Power:** 240 watts (continuous), 120 watts (AES)
- Directivity:** 85° conical
- Elements:** (1) 5" coaxial with a 1" dome high frequency element, (1) 5" passive radiator
- Impedance:** 16 Ω
- Connectors:** (1) screw terminal block with input +/- and link +/-

Mechanical Specifications

- IP Rating:** IP55 indoor
- Rigging:** (4) M6 points
- Weight:** 9.4 lb / 4.3 kg
- Construction:** Finland birch plywood (phenolic resin), three coats of polyurea, matte salt and UV resistant coating, A4 (316) stainless steel hardware, galvanized and powder-coated black or white steel input plate, 3D spacer mesh fabric
- Dimensions:** 7.5" (190 mm) x 7.5" (190 mm) x 8.2" (208 mm)
- Colors:** Stocking black and white, custom colors and fabrics available
- Accessories:** C-Clamp (wall-, truss-, mic stand- or ceiling-mount), Universal Mounting Plate, Pole Mount Adaptor, L-Bracket, Tube Mount, Swivel Mount

DIRECTIVITY

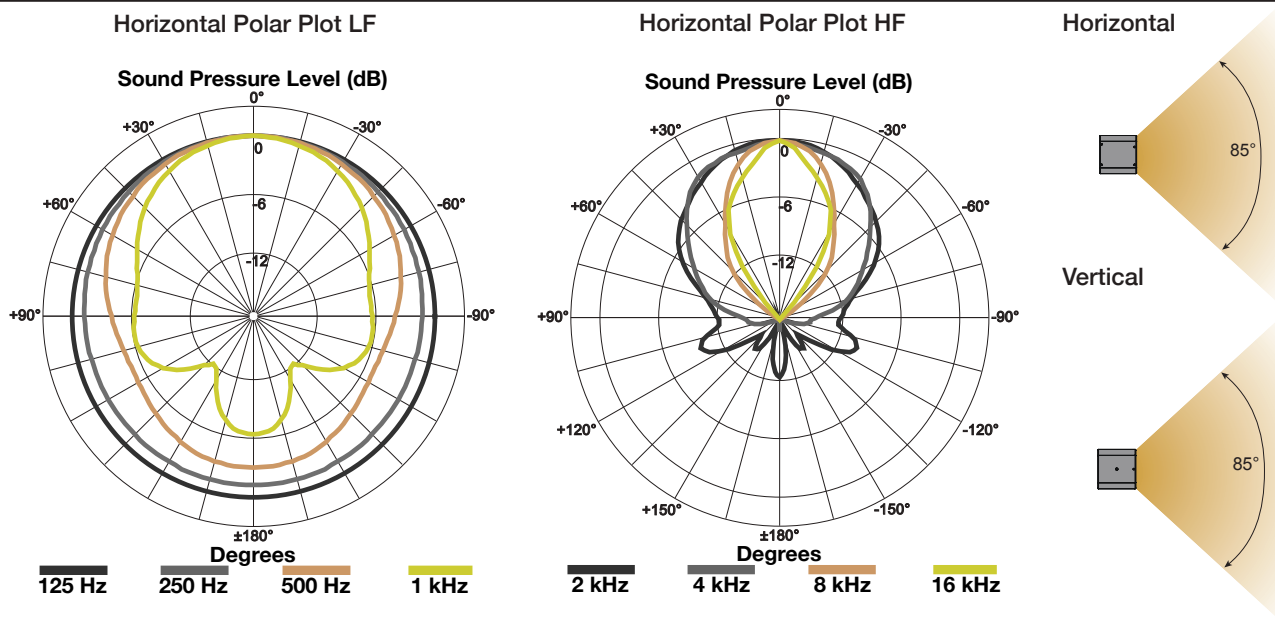

FREQUENCY RESPONSE

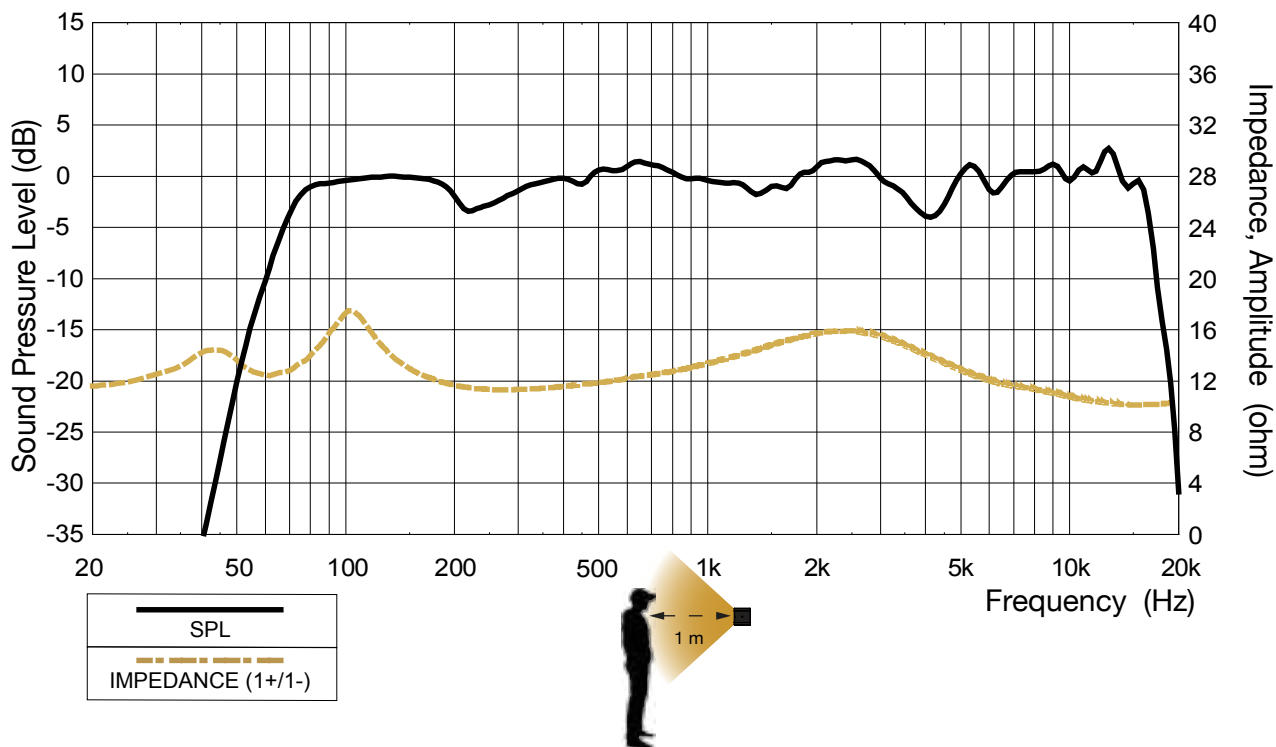

WIRING

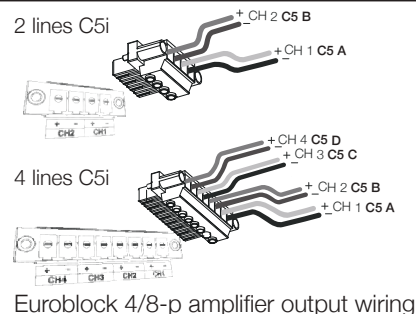
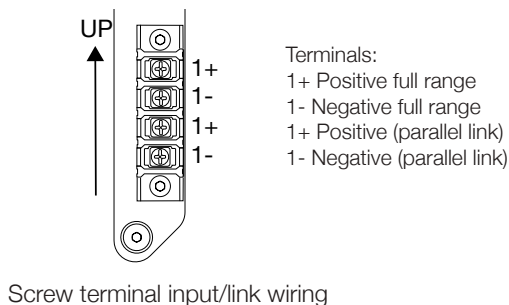
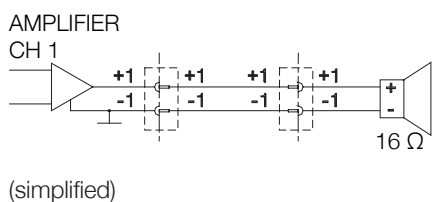

DIMENSIONS

RIGGING

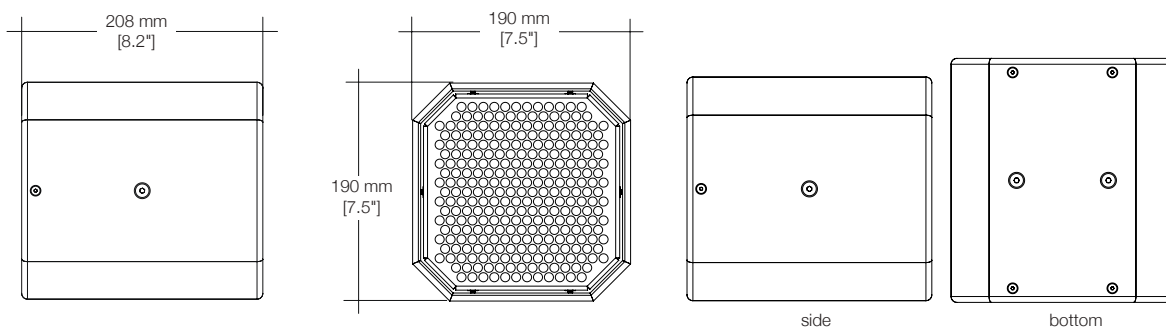

- (4) points M6**
- Bottom: (2) points M6 – for mounting plate and pole mount
 - Sides: (2) points M6 – 1 each side for C-Clamp

ACCESSORIES



Contact

For more product or service information please contact the 1 SOUND headquarters.

1 SOUND, Manufacturer
 USA Distributor
 34 Apple Street
 Tinton Falls, NJ 07724

tel. +1-732-798-9900
 sales@1-sound.com

Warranty

All manufactured 1 SOUND products are warranted to be free from defects in materials or workmanship for a period of 3 years from original purchase. If there is specific hardware or grilles you might want replaced or any repairs needed please contact your region's authorized 1 SOUND distributor.



CANNON C5M

HIGH FIDELITY COAXIAL INSTALLATION SPEAKER ENCLOSURE



FEATURES

- 5" + 1" Coaxial Transducer
- 5" Passive Radiator
- Bass Response Down to 65 Hz
- 85° Conical Coverage Pattern
- High Fidelity
- IP55 + Salt Water Resistant
- All stainless steel 316 hardware

APPLICATIONS

- Outdoor Systems
- Maritime Resorts
- Cruise Ships
- Restaurants

DESCRIPTION

The C5m is a unique point source, coaxial loudspeaker. Each Cannon model utilizes a low frequency driver with a coaxially mounted 1" silk dome high frequency driver. The Cannons' silk dome driver is a purpose-built, ferrofluid-cooled design that enables high sound pressure levels, with improved sound quality, as well as consistency and durability over time. The enclosure also incorporates a rear-facing passive radiator specifically tuned to extend the bass frequency response. These key features allow the C5m to provide the sound quality of a studio monitor.

The C5m features a marine grade cable gland and 6 feet of two-core, 16 gauge speaker cable in black or white. The marine versions of the Cannon Series enclosures also feature all stainless steel 316 hardware, input plates, and grilles.

SPECIFICATIONS

Audio Specifications

- Description:** Passive 5" coaxial with a 5" passive radiator
- Bandwidth:** 65 Hz - 18 kHz (-6 dB)
- Max SPL:** 113 dB SPL @ 1 m w/ preset
- Power:** 240 watts (continuous), 120 watts (AES)
- Directivity:** 85° conical
- Elements:** (1) 5" coaxial with a 1" dome high frequency element, (1) 5" passive radiator
- Impedance:** 16 Ω
- Connectors:** (1) marine grade cable gland with 6' (180 cm) unterminated 16/2 cable

Mechanical Specifications

- IP Rating:** IP55 indoor/outdoor and salt water resistant
- Rigging:** (4) M6 points
- Weight:** 9.4 lb / 4.3 kg
- Construction:** Finland birch plywood (phenolic resin), three coats of polyurea, matte salt- and UV-resistant coating, A4 (316) stainless steel hardware, grilles, and input plate, 3D spacer mesh fabric
- Dimensions:** 7.5" (190 mm) x 7.5" (190 mm) x 8.2" (208 mm)
- Colors:** Stocking black and white, custom colors and fabrics available
- Accessories:** C-Clamp (wall-, truss-, mic stand- or ceiling-mount), Universal Mounting Plate, Pole Mount Adaptor, L-Bracket, Tube Mount, Swivel Mount

DIRECTIVITY

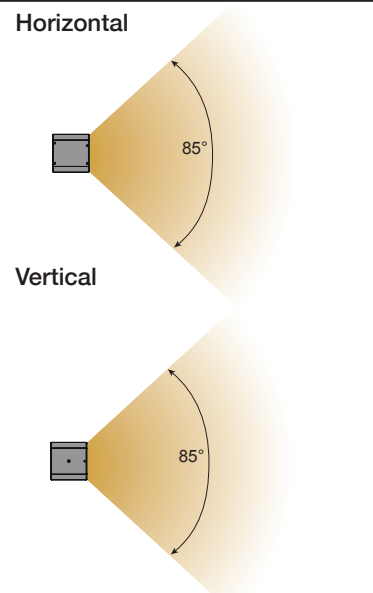
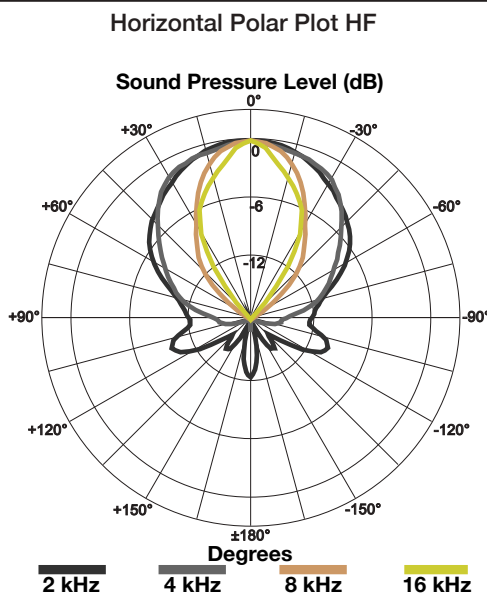
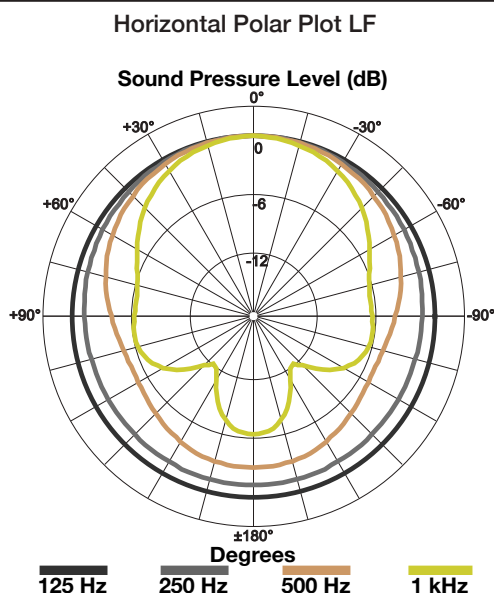

FREQUENCY RESPONSE

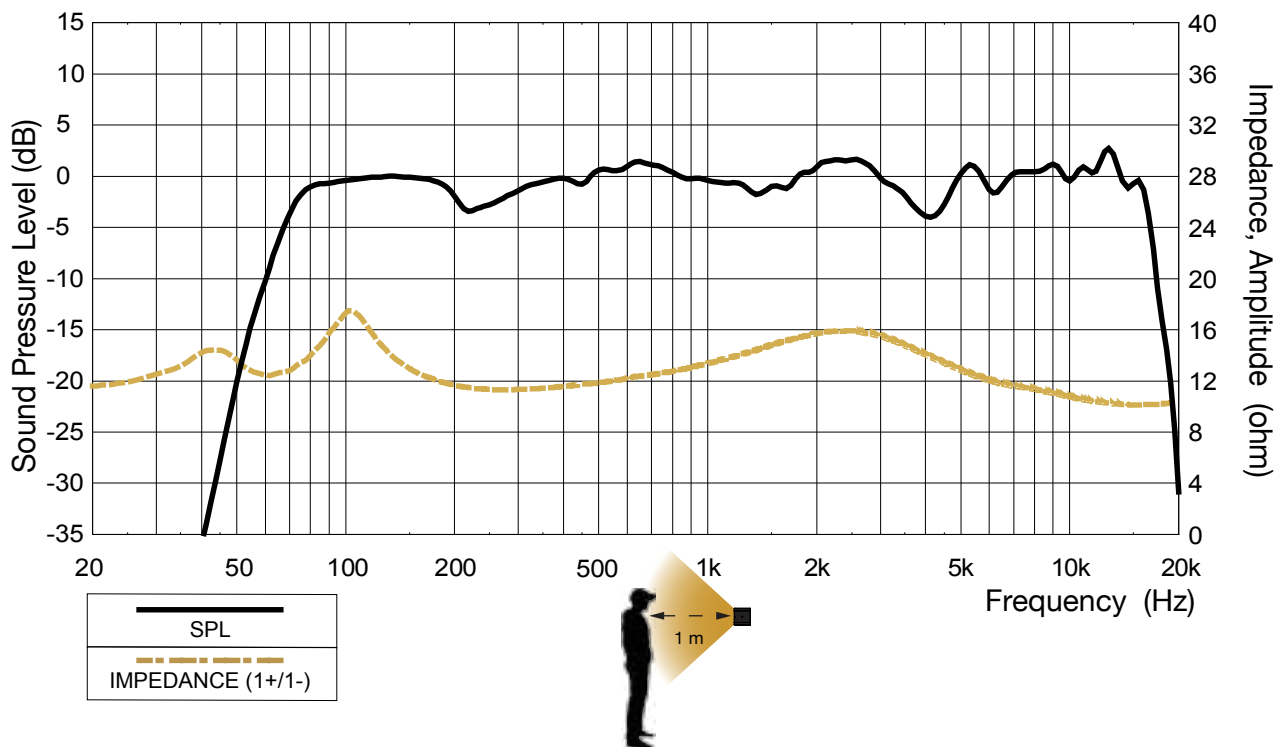

WIRING

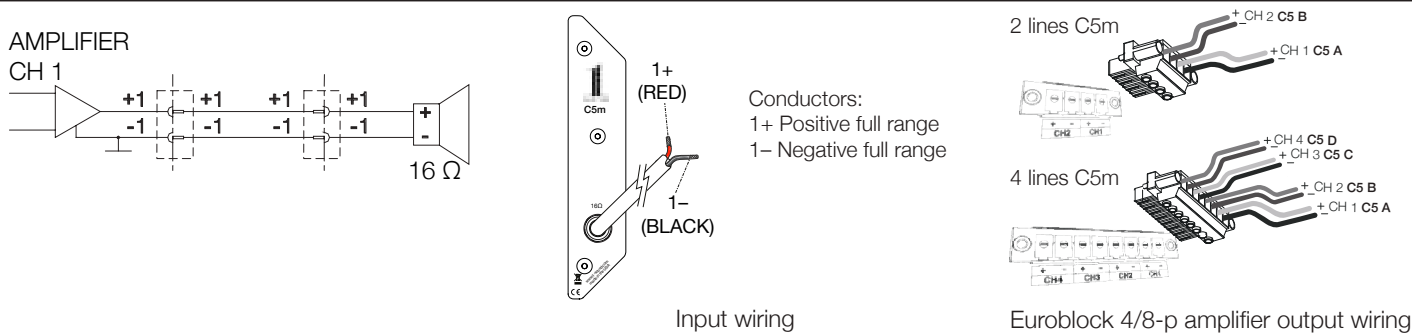

DIMENSIONS

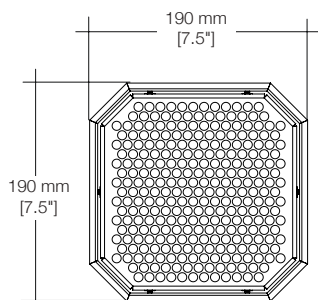
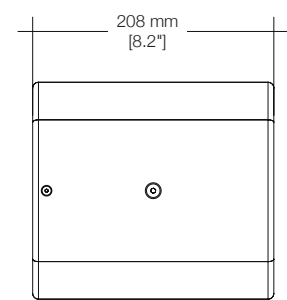

RIGGING

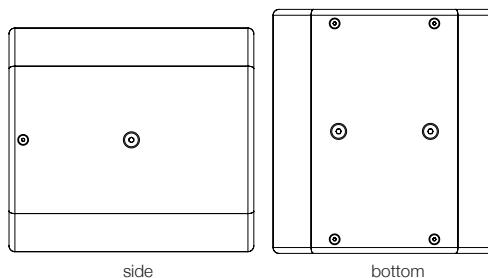

- (4) points M6**
- Bottom: (2) points M6 – for mounting plate and pole mount
 - Sides: (2) points M6 – 1 each side for C-Clamp

ACCESSORIES



Contact

For more product or service information please contact the 1 SOUND headquarters.

1 SOUND, Manufacturer
 USA Distributor
 34 Apple Street
 Tinton Falls, NJ 07724

tel. +1-732-798-9900
 sales@1-sound.com

Warranty

All manufactured 1 SOUND products are warranted to be free from defects in materials or workmanship for a period of 3 years from original purchase. If there is specific hardware or grilles you might want replaced or any repairs needed please contact your region's authorized 1 SOUND distributor.

