

## 19" ventilated blind panel with hexagonal perforation

A 19" blind panel made of steel with a plate thickness of 1.5 mm and provided with a black (RAL 9004) structured powder coating. The panel is perforated with hexagonal ventilation holes to help cool the stored equipment.

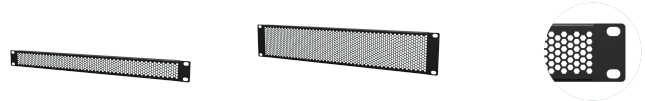
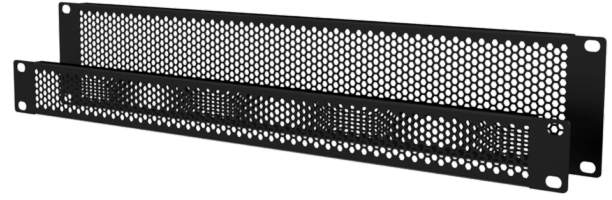

### Product Features:

Dimensions	483 x 43.7 x 10 mm (W x H x D) (BSVH01)
	483 x 88.1 x 10 mm (W x H x D) (BSVH02)
Weight	0.22 kg (BSVH01)
	0.40 kg (BSVH02)
Unit height	1 HE (BSVH01)
	2 HE (BSVH02)

### Variants:

- BSV01H - 1 unit
- BSV02H - 2 units

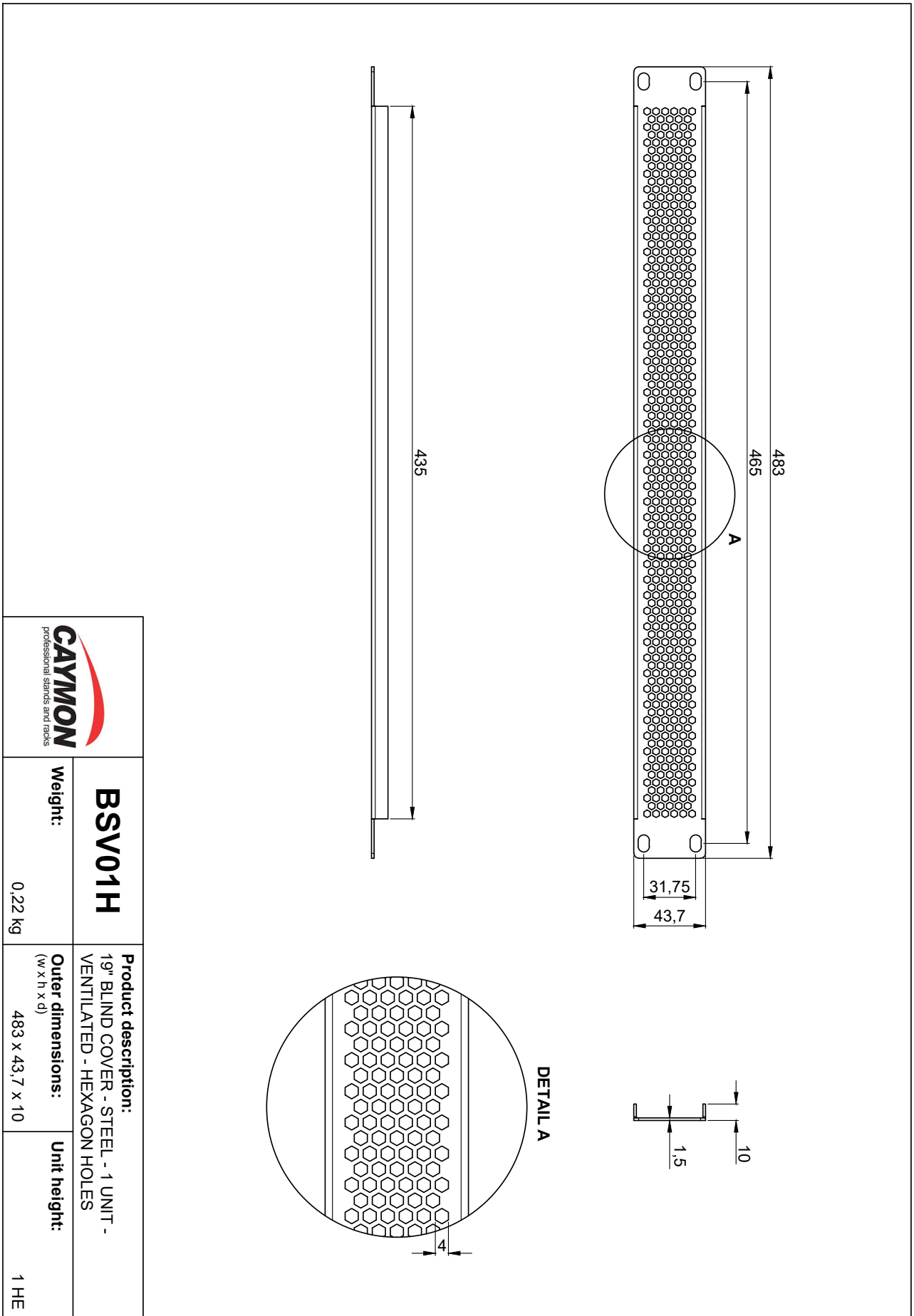

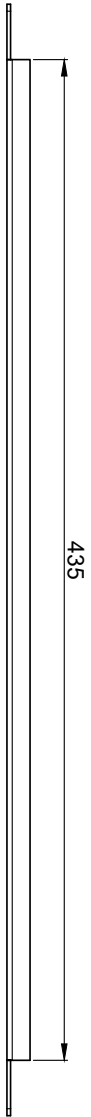
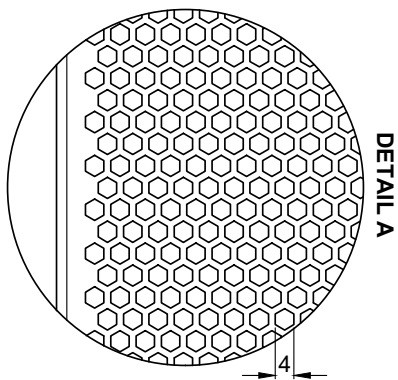
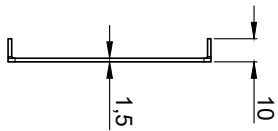
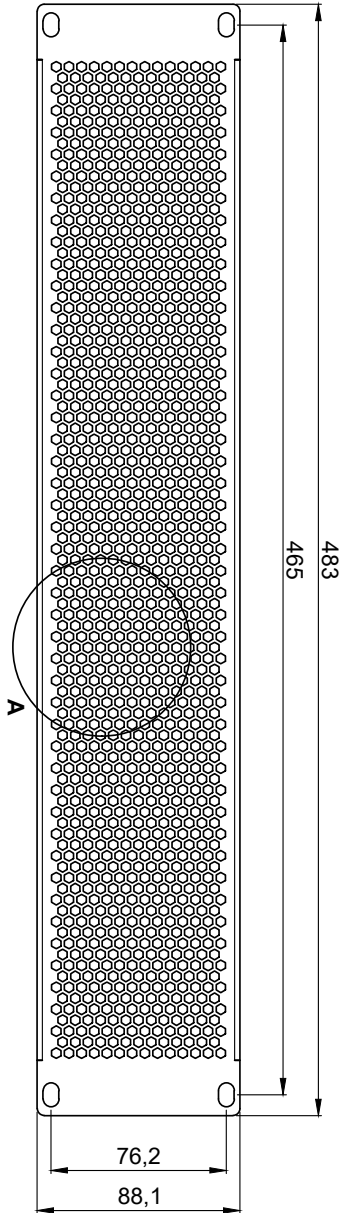

		<b>BSV02H</b>	<b>Product description:</b> 19" BLIND COVER - STEEL - 2 UNIT - VENTILATED - HEXAGON HOLES	<b>Outer dimensions:</b> (w x h x d) 483 x 88,1 x 10	<b>Unit height:</b> 2 HE