

NWP300 & NWP400

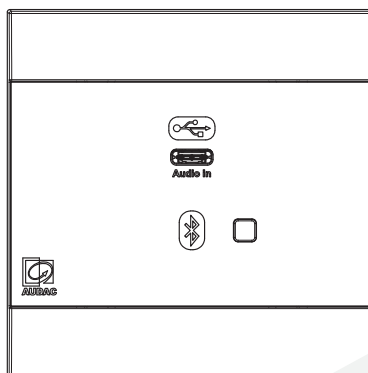

ADDITIONAL INFORMATION

This manual is put together with much care, and is as complete as could be on the publication date. However, updates on the specifications, functionality or software may have occurred since publication. To obtain the latest version of both manual and software, please visit the Audac website @ audac.eu.

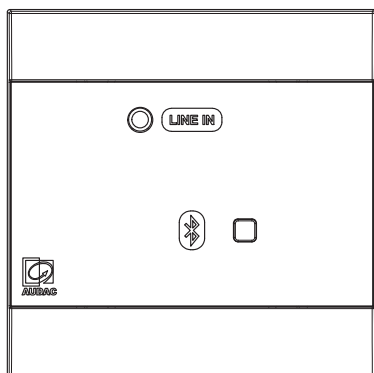

REV-1.2

Table of contents



Introduction	05
Networked audio in- & output wall panels	05
Precautions	06
Chapter 1	08
Connections and connectors	08
Network settings	09
Chapter 2	10
Overview front panel	10
Front panel description	10
Overview rear panel	11
Rear panel description	11
Installation	12
Chapter 3	12
Quick start guide	12
Technical specifications	14
Notes	15

Introduction

Networked audio in- & output wall panels

NWP series are Dante™/AES67 networked audio in & output wall panels featuring various connection options, ranging from XLR to USB Type-C and all with Bluetooth connection. The audio inputs can be switched between line-level and microphone-level audio signals and phantom power (+48 V DC) can be applied to the XLR input connectors for powering condenser microphones. Various further integrated DSP functions such as EQ, automatic gain control, and other device settings can be configured through the AUDAC Touch™.

The IP-based communication makes it future-proof while also being backward compatible with many existing products. Thanks to the limited PoE power consumption, the NWP series is compatible with any PoE network-based installation.

Besides the elegant design, the front panel is finished with high-quality fingerprint-resistant glass. The wall panels are compatible with standard EU-style in-wall boxes, making the wall panel the ideal solution for solid and hollow walls. Black and white color options are available to blend into any architectural design.

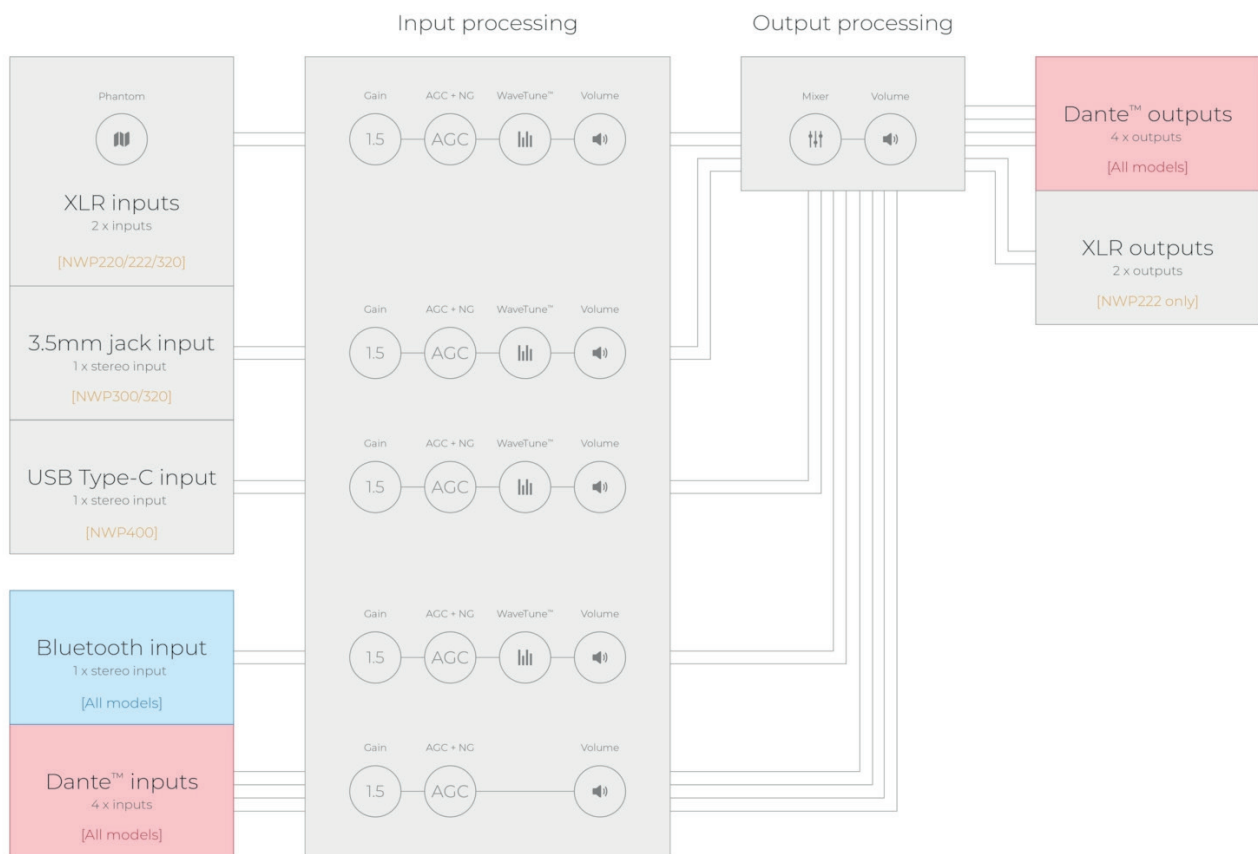

READ FOLLOWING INSTRUCTIONS FOR YOUR OWN SAFETY

ALWAYS KEEP THESE INSTRUCTIONS. NEVER THROW THEM AWAY

ALWAYS HANDLE THIS UNIT WITH CARE

HEED ALL WARNINGS

FOLLOW ALL INSTRUCTIONS

NEVER EXPOSE THIS EQUIPMENT TO RAIN, MOISTURE, ANY DRIPPING OR SPLASHING LIQUID. AND NEVER PLACE AN OBJECT FILLED WITH LIQUID ON TOP OF THIS DEVICE

NO NAKED FLAME SOURCES, SUCH AS LIGHTED CANDLES, SHOULD BE PLACED ON THE APPARATUS

DO NOT PLACE THIS UNIT IN AN ENCLOSED ENVIRONMENT SUCH AS A BOOKSHELF OR CLOSET. ENSURE THERE IS ADEQUATE VENTILATION TO COOL THE UNIT. DO NOT BLOCK THE VENTILATION OPENINGS.

DO NOT STICK ANY OBJECTS THROUGH THE VENTILATION OPENINGS.

DO NOT INSTALL THIS UNIT NEAR ANY HEAT SOURCES SUCH AS RADIATORS OR OTHER APPARATUS THAT PRODUCE HEAT

DO NOT PLACE THIS UNIT IN ENVIRONMENTS WHICH CONTAIN HIGH LEVELS OF DUST, HEAT, MOISTURE OR VIBRATION

THIS UNIT IS DEVELOPED FOR INDOOR USE ONLY. DO NOT USE IT OUTDOORS

PLACE THE UNIT ON A STABLE BASE OR MOUNT IT IN A STABLE RACK

ONLY USE ATTACHMENTS & ACCESSORIES SPECIFIED BY THE MANUFACTURER

UNPLUG THIS APPARATUS DURING LIGHTNING STORMS OR WHEN UNUSED FOR LONG PERIODS OF TIME

ONLY CONNECT THIS UNIT TO A MAINS SOCKET OUTLET WITH PROTECTIVE EARTHING CONNECTION

USE THE APPARATUS ONLY IN MODERATE CLIMATES



CAUTION - SERVICING

This product contains no user serviceable parts. Refer all servicing to qualified service personnel. Do not perform any servicing (unless you are qualified to)



EC DECLARATION OF CONFORMITY

This product conforms to all the essential requirements and further relevant specifications described in following directives: 2014/30/EU (EMC), 2014/35/EU (LVD) & 2014/53/EU (RED).



WASTE ELECTRICAL AND ELECTRONIC EQUIPMENT (WEEE)

The WEEE marking indicates that this product should not be disposed with regular household waste at the end of its life cycle. This regulation is created to prevent any possible harm to the environment or human health.

This product is developed and manufactured with high quality materials and components which can be recycled and/or reused. Please dispose this product at your local collection point or recycling centre for electrical and electronic waste. This will make sure that it will be recycled in an environmentally friendly manner, and will help to protect the environment in which we all live.

FCC WARNINGS

This device complies with Part 15 of the FCC rules and Industry Canada license-exempt RSS standard(s). Operation is subject to the following two conditions: (1) this device may not cause harmful interference, and (2) this device must accept any interference received, including interference that may cause undesired operation.

The manufacturer is not responsible for any radio or TV interference caused by unauthorized modifications or change to this equipment. Such modifications or change could void the user's authority to operate the equipment.

This radio transmitter (identify the device by certification number or model number if Category II) has been approved by Industry Canada to operate with the antenna types listed below with the maximum permissible gain indicated. Antenna types not included in this list, having a gain greater than the maximum gain indicated for that type, are strictly prohibited for use with this device.

This equipment has been tested and found to comply with the limits for a Class B digital device, pursuant to part 15 of the FCC Rules. These limits are designed to provide reasonable protection against harmful interference in a residential installation. This equipment generates, uses and can radiate radio frequency energy and, if not installed and used in accordance with the instructions, may cause harmful interference to radio communications. However, there is no guarantee that interference will not occur in a particular installation. If this equipment does cause harmful interference to radio or television reception, which can be determined by turning the equipment off and on, the user is encouraged to try to correct the interference by one or more of the following measures:

- Reorient or relocate the receiving antenna.
- Increase the separation between the equipment and receiver.
- Connect the equipment into an outlet on a circuit different from that to which the receiver is connected.
- Consult the dealer or an experienced radio/TV technician for help.

The device has been evaluated to meet general RF exposure requirement.

To maintain compliance with FCC's RF exposure guidelines, this equipment should be installed and operated with a minimum distance of 20cm between the radiator and your body.

Connections

CONNECTION STANDARDS

The in- and output connections for AUDAC audio equipment are performed according to international wiring standards for professional audio equipment

3.5 mm jack:

For unbalanced line input connections

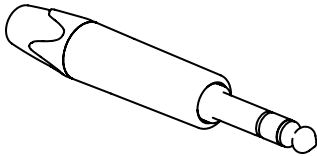

Tip: Left
Ring: Right
Sleeve: Ground

RJ45 (Network, PoE)

connections

Network



Pin 1	White-Orange
Pin 2	Orange
Pin 3	White-Green
Pin 4	Blue
Pin 5	White-Blue
Pin 6	Green
Pin 7	White-Brown
Pin 8	Brown

Ethernet (POE):

Used for connecting the NWP series in your Ethernet network with PoE (power over Ethernet). The NWP series complies with the IEEE 802.3 af/at standard, which allows IP-based terminals to receive power, in parallel to data, over the existing CAT-5 Ethernet infrastructure without the need to make any modifications in it.

PoE integrates data and power on the same wires, it keeps the structured cabling safe and does not interfere with concurrent network operation. PoE delivers 48v of DC power over unshielded twisted-pair wiring for terminals consuming less than 13 watts of power.

The maximum output power is depending on the power delivered by the network infrastructure. In case the network infrastructure is not capable of delivering sufficient power, use a PoE injector to the NWP series.

While CAT5E network cable infrastructure is sufficient for handling the required bandwidth, it is recommended to upgrade the network cabling to CAT6A or better cabling to achieve the best possible thermal and power efficiency throughout the system when drawing higher powers over PoE.

Network settings

STANDARD NETWORK SETTINGS

DHCP: **ON**

IP Address: Depending on DHCP

Subnet Mask: 255.255.255.0 (Depending on DHCP)

Gateway: 192.168.0.253 (Depending on DHCP)

DNS 1: 8.8.4.4 (Depending on DHCP)

DNS 2: 8.8.8.8 (Depending on DHCP)

Overview front panel

The front panel of the NWP series is finished with high-quality fingerprint-resistant glass and features various connection options, ranging from XLR to USB Type-C, and all with Bluetooth connection. Buttons on the front panel either change the input level between the microphone and line level or make the wall panel visible for Bluetooth connection, or both based on the model.

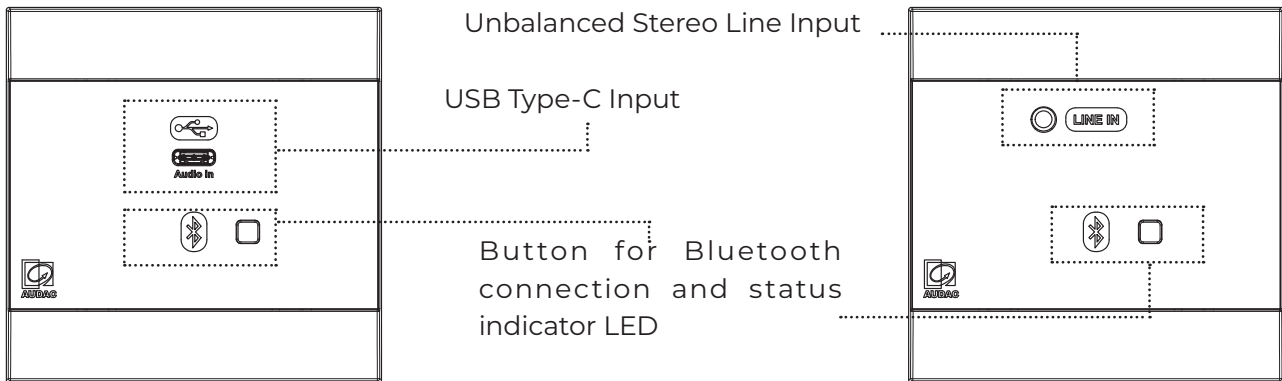

Front panel description

Unbalanced Stereo Line Input

An unbalanced stereo audio source can be connected to this 3.5mm jack stereo line input.

Button Bluetooth Connection

Pressing and holding the button enables Bluetooth pairing when both LED blink in blue color. The brightness of LED indicators is adjustable from the AUDAC Touch™.

The Bluetooth name and number of known devices can be set from the AUDAC Touch™.

Overview rear panel

The rear of the NWP series contains an ethernet connection port which is used to connect the wall panel to the RJ45 connector. As the NWP series are Dante™/AES67 networked audio in & output wall panels with PoE, all data flow and powering are done through this single port.

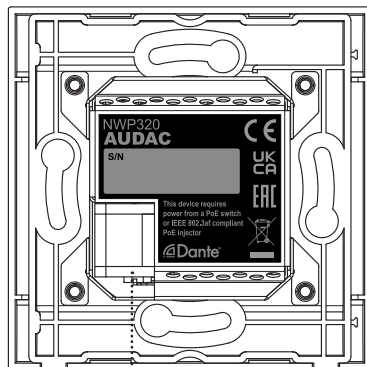

.....Ethernet connection

Rear panel description

Ethernet connection

The Ethernet connection is the essential connection for the NWP series. Both audio transmission (Dante/AES67), as well as control signals and power (PoE), are distributed over the Ethernet network. This input shall be connected to your network infrastructure. The LEDs accompanied by this input are indicating the network activity.

Installation

This chapter guides you through the setup process for a basic setup where an NWP series networked wall panel should be connected to a system with a wired network. The wall panels are compatible with standard EU-style in-wall boxes, making the wall panel the ideal solution for solid and hollow walls. Provide a twisted pair cable (CAT5E or better) from the network switch to the wall panel. The maximum safest distance between the PoE switch and the wall panel should be 100 meters.

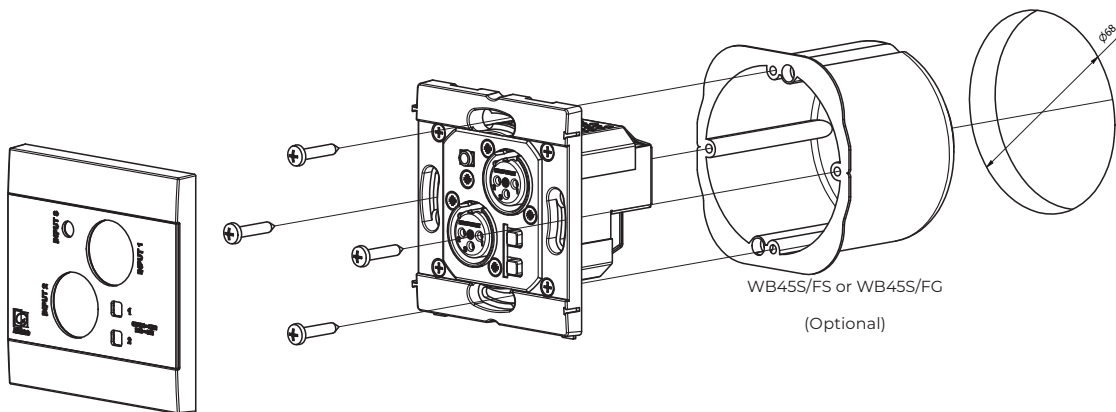

Removing the front cover

The front panel of the NWP series can be removed by using a flat head screwdriver in 5 steps.

Step 1:

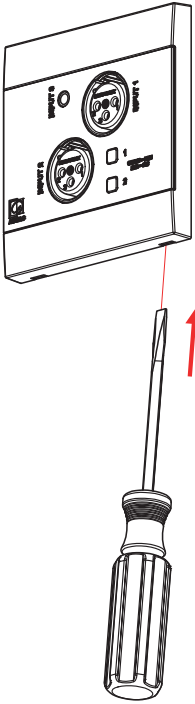

Step 2:

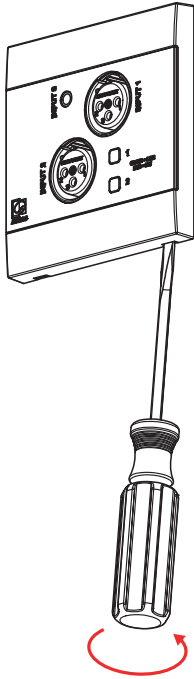

Step 3:

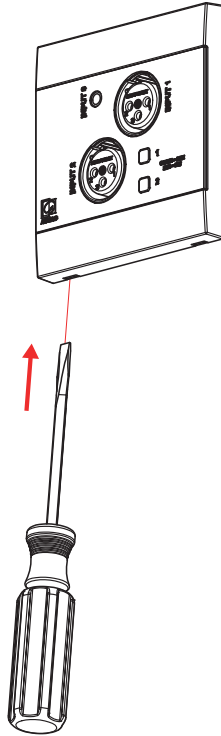

Step 4:

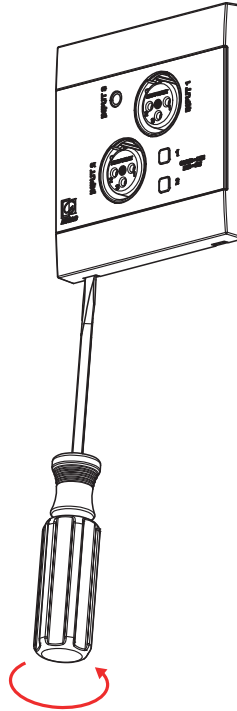

Step 5:



Chapter 3



Quick start guide

This chapter guides you through the setup process for a NWP series wall panel where the wall panel is a Dante source connected to the network. The control of the system is done through the NWP or Audac Touch™.

Connecting the NWP series

1) Connecting the NWP series to your network

Connect your NWP series wall panel to a PoE-powered Ethernet network with a Cat5E (or better) networking cable. In case the available Ethernet network is not PoE compatible, an additional PoE injector shall be applied in between. The operation of the NWP series wall panel can be monitored through the indicator LEDs on the front panel of the unit, which indicate the input level or Bluetooth status.

2) Connecting the XLR

The XLR connector shall be connected to the XLR connector on the front panel, Depending on the NWP model, two XLR inputs or two XLR inputs and two XLR outputs can be connected on the front panel.

3) Connecting the Bluetooth

Pressing and holding both buttons enables Bluetooth pairing when both LEDs blink in blue color. The Bluetooth antenna is located behind the front panel, so the front panel shall remain uncovered for a reliable Bluetooth signal reception.

Factory Reset

Press button 1 for 30 seconds. Once the LEDs start blinking in white, remove the network cable from the device within 1 minute. Replug the network cable, the device will be in factory defaults after repowering.

Configuring the NWP series

1) Dante controller

Once all connections are made, and the NWP series wall panel is operational, the routing for the Dante audio transfer can be made.

For the configuration of the routing, the Audinate Dante Controller software shall be used. The use of this tool is extensively described in the Dante controller user guide which can be downloaded from both Audac (audac.eu) and Audinate (audinate.com) websites.

In this document, we quickly describe the most basic functions to get you started.

Once the Dante controller software is installed and running, it will automatically discover all the Dante-compatible devices in your network. All devices will be shown on a matrix grid with on the horizontal axis all the devices with their receiving channels shown and on the vertical axis all the devices with their transmitting channels. The shown channels can be minimized and maximized by clicking the '+' and '-' icons.

Linking between the transmitting and receiving channels can be done by simply clicking the cross points on the horizontal and vertical axis. Once clicked, it only takes a few seconds before the link is made, and the cross point will be indicated with a green checkbox when successful.

To give custom names to the devices or the channels, double-click the device name and the device view window will pop up. The device name can be assigned in the 'Device config' tab, while the transmitting and receiving channel labels can be assigned under the 'Receive' and 'Transmit' tabs.

Once any changes are made to linking, naming, or any other, it is automatically stored inside the device itself without requiring any save command. All settings and linkings will be automatically recalled after power off or re-connection of the devices.

Besides the standard and essential functions described in this document, the Dante Controller software also includes many additional configuration possibilities that might be required depending on your application requirements. Consult the complete Dante controller user guide for more information.

2) NWP series settings

Once the Dante routing settings are made through the Dante Controller, other settings of the NWP series wall panel itself can be configured using the Audac Touch™ platform, which can be freely downloaded and operated from various platforms. This is very intuitive to be operated and automatically discovers all available compatible products in your network. Available settings include input gain range, output mixer, as well as advanced configurations such as WaveTune™ and much more.

Technical specifications



Inputs	Type	USB Type-C (NWP400)
	Type	Unbalanced Stereo Line (NWP300)
	Connector	Front: 3.5 mm jack
	Impedance	10 kOhm Unbalanced
	Sensitivity	0 dBV
	THD+N	<0.02% - 0.013%
	Signal / Noise	> 93 dBA
	Type	Bluetooth receiver (Version 4.2)
	Type	Dante / AES67 (4 Channels)
		RJ45 with indicator LEDs
Configurable Settings		Gain, AGC, Noise Gate, WaveTune™, Maximum Volume
Output	Type	Dante / AES67 (4 Channels)
	Connector	RJ45 with indicator LEDs
	Output level	Switch between 0dBV and 12 dBV
Configurable Settings		8 Channels Mixer, Maximum Volume, Gain
Power supply		PoE
Power consumption	(BT paired)	2.2W (NWP300),1.9W (NWP400)
Phantom power		48V DC
Noisefloor		-76.5 dBV
Dimensions	(W x H x D)	80 x 80 x 52.7 mm
Built-In depth		75 mm
Colours		NWPxxx/B Black (RAL9005) NWPxxx/W White (RAL9003)
Front finish		ABS with glass
Accessories		US Standard Installation Kit
Compatible devices		All Dante compatible devices

*Input and output sensitivity levels defined are referred to a -13 dB FS (Full Scale) level, which is consequent through digital Audac devices and can be digitally gained when interfacing with 3rd party equipment.



Discover more on audac.eu