

SOUND DEVICES



833

Portable Compact Mixer-Recorder

User Guide v10.01

Table of Contents

Welcome to the 833	3
Panel Views	4
Home Screen	10
Channel Screen	12
Virtual Keyboard	16
Phrase Manager	17
Menus	18
Power	19
Channel Setup	21
Channels 7-8	23
Buses	24
Outputs	26
Limiters	29
Automixer	30
Meters	33
Timecode	35
Record/Play	37
Q-marks	41
Files	42
Slate/Coms>Returns	49
SuperSlot	51
SL-2	51
SL-2 Options	55
Receiver Setup Screens	58
A20-Nexus/A20-Nexus Go	67
System	68
Plugins	71
The 833 +4 Plugin	72
Noise Suppression Plugins	73
Controllers	76
Supported Third-Party Controllers	85
Toggle Switch Action	86
Menu + PFL Switch Action	87
Front Panel Shortcuts	88
USB Keyboard	90
X-KEYS® PROGRAMMABLE KEYPADS, STICKS & KEYBOARDS	91
SD-Remote	92
Quick Setup	108
USB-A	108
USB-C	108
Specifications	109
Legal Notices	113
Warranty	115
Glossary	116

Welcome to the 833

The 833 is the professional's tool for mobile and small productions. Like the popular Sound Devices 633, the 833 is small, lightweight, and compact. A tactile interface with dedicated faders, trim knobs, and PFL switches makes this mixer-recorder ideal for run-and-gun bag use.

- 6 ultra low-noise, 8-Series microphone preamplifiers
- 8 channels, 6 buses, 12 tracks
- 6 analog outputs
- Ultra-accurate timecode
- 256 GB internal SSD, 2 SD card slots
- USB-A and C ports for SD-Remote app, linear fader control via MCU, keyboard, and file transfer
- Dugan Automixing/MixAssist for up to 8 channels
- 24-bit at up to 192 KHz recording
- 32-bit floating point ISO recording
- Optional [NoiseAssist](#) and [CEDAR sdnx](#) noise suppression plugins
- Optional [+4 Plugin](#) adds four fully-featured channels
- Optional integrated digital wireless with the A20-Nexus or SL-2 (plus SuperSlot receivers)

Our friendly and knowledgeable support team, based in the USA and the UK, is here for all your questions and comments. Our job is to make your job easier.

We are honored to be part of your kit.

Sincerely,
Sound Devices

Panel Views

Front Panel



1: Channel Trim

Turns the channel on/off and sets the input gain for the channel. To conserve power, turn off unused channels by rotating channel trim fully counter-clockwise. Channel 7-8 trims are accessible via the Channels 7-8 menu or using */** + PFL switch shortcuts. Use Toggle Switch Actions to set the Select and /or HP knobs as trims for Ch 7,8.

2: Channel LED Ring

Provides visual indication of channel signal condition, solo and mute, and whether a channel is on or off.

3: PFL Switch

Pre/Post Fade Listen selects the channel in the headphones for Pre/Post Fade Listen while simultaneously entering the channel screen. Also used for accessing virtual keyboard for channel naming and various shortcuts. Channel 9-10 PFLs are accessible via the Channels 9-10 menu or using */** + PFL switch shortcuts. Use Toggle Switch Actions to set the Select and /or HP knobs as PFLs for Ch 9,10.

4: Channel Fader

Controls the audio level of the channel as it contributes to the L/R mix and any destinations selected in routing as "Post". Channel 7-8 faders are accessible via the Channels 7-8 menu or using */** + PFL switch shortcuts. Use Toggle Switch Actions to set the Select and /or HP knobs as faders for Ch 7,8.

5: Meter Button

Push to view and select various metering presets. Used with Select knob. Press again to return to Home Screen. Push with channel Select switched 1-6 for shortcut to Meters Preset 1-6. Push and rotate HP knob to zoom meter scale. Push and Push HP knob to access Receiver Overview screen if a SuperSlot accessory is connected.

6: Transport Controls

A joystick (with its illuminated LED ring) on the front panel is used to perform various transport control functions. (See table). The ring LED will flash orange indicating post roll while writing to media.

Function	Action
Record	Push up the Transport control to begin recording a new file. The LED ring illuminates red while recording is underway.
Stop	Press in the Transport control to stop recording or playback. While in standby, press and hold to display next take name.
Play	Push down on the Transport control to begin playback of the last file recorded or file currently loaded. While in playback, push down again to pause playback. The LED ring as

	well as the active file in the display will flash to indicate that Pause is active. Push down again to continue playback.
Rewind / Load Previous Take	While in standby, push left to load the previous take. While in playback, push and hold left to rewind. When the 833 is playing back or paused, moving the joystick to the left (<<) rewinds at 2x speed, then after holding for 5 seconds, it increases to 16x speed. Push Left while holding Select to delete the current Q-mark.
Fast Forward / Load Next Take	While in standby, push right to load the next take. While in playback, push and hold right to rewind. When the 833 is playing back or paused, moving the joystick to the right (>>) fast forwards at 2x speed, then after holding for 5 seconds, it increases to 16x speed. Push right while holding Select to add a Q-mark.
Scrub	While playing or paused, press the headphone knob >0.5 s to enter Scrub mode. Then rotate clockwise for fast forward or counter-clockwise for rewind speeds of 0x, 1/8x, 1/4x, 1/2x, 1x, 2x, 4x, 8x, and 16x. The audio may be heard in scrub mode up to 2x speed.

7: Power Switch/LED Indicator

Turns the power on and off. Switch LED ring indicates the following:

1. Power condition: green = good, yellow = warning, red = shutdown imminent.
2. Flashing blue = power is off and holding timecode.
3. Continuous blue = booting up.
4. Flashing yellow = unit is off and charging L-mount batteries.
5. Continuous yellow = unit is off and both L-mount batteries are fully charged.

8: Menu Button

Push to enter the Main menu. Also used to exit menus. The Menu button will flash red to indicate clipping on the headphones. Press with Channel Select switches 1-6 for shortcuts to Menu Favorites 1-6.

9: Headphone Knob

1. Rotate to control headphone volume. Can be disabled. See System > Headphone Volume Lock.
2. Press to open headphone preset menu and select.
3. Menu navigation and push to select.
4. Press Menu and HP knob to enter Take List.
5. Press > 0.5 s during playback to enter audio scrub mode.

10: Rtn/Fav Switch

Toggle Rtn and Fav actions. Soft button for menus.
Mappable functions via the Toggle Switch Action menu.

11: ** Switch

User-programmable shortcut toggles.
Mappable functions via the Toggle Switch Action menu.

12: Mic/Tone Switch

Toggle slate mic and tone generator. Soft button for menus.
Hold Select then activate Tone switch for L-Ident tone.
Mappable functions via the Toggle Switch Action menu.

13: Select Knob

1. Push to view Outputs list, rotate and push to Select Output Screen. Push Meter Button to return to Home Screen.
2. Rotate to select track in display, push both Meter and Select at the same time to arm/disarm track. While holding the Meter Button, multiple consecutive tracks may be armed by holding in the Select knob and rotating.
3. Use with Meter Button to scroll through meter views then push to Select.
4. Push with Channel Select switches 1-6 for shortcut to Bus 1-4, L,R routing.

5. Menu navigation and push to Select.
6. Hold then press >>, <<, to add, delete Q-marks during recording and playback.

14: LCD Display

Displays audio metering, files names, timecode, settings, menus etc. For operating in direct sunlight, enable Daylight Mode in the System > Display menu or by pressing the Select and HP encoders at the same time.

Left Side Panel

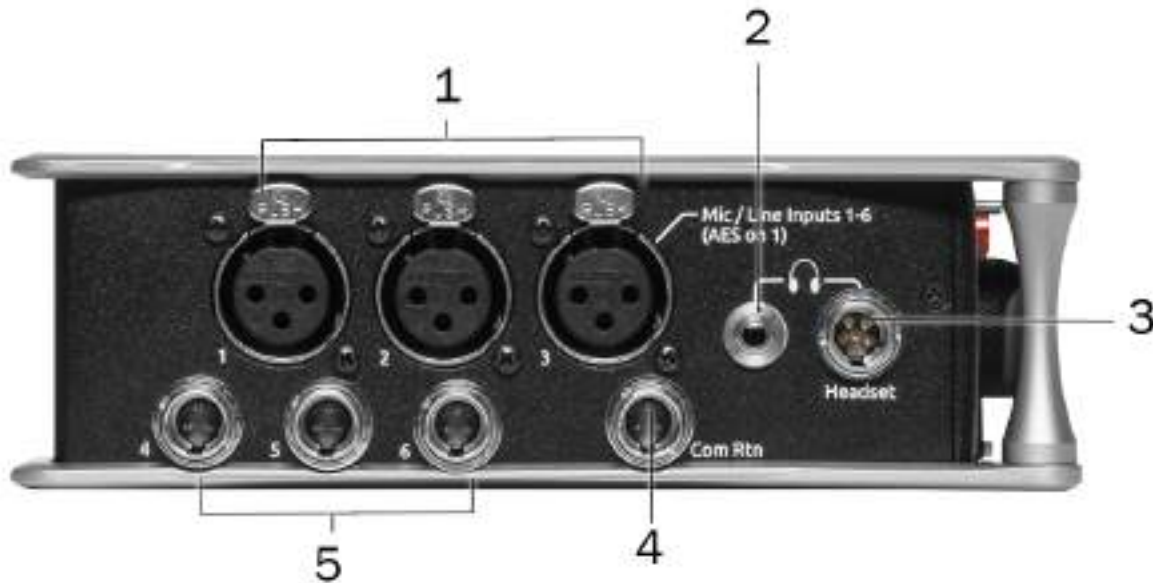

1: Inputs 1-3 Female XLR Jacks

Active-balanced analog microphone or line-level inputs. Input 1 can also accept AES3 or AES42 signal. [pin-1 = ground, pin-2 = hot (+), and pin-3 = cold (-)]. 110 ohm cables should be used for AES3 or AES42 inputs.

2: Headphone 3.5 mm Jack

Unbalanced output and TRS headphone output. Warning! This output can drive headphones to potentially dangerous levels. Routing determined in the Outputs menu. [Sleeve = ground, tip = left, ring = right].

3: Headphone/Headset TA5 Jack

Headphone and slate microphone connections [pin-1 = HP right, pin-2 = HP left, pin-3 = ground, pin-4 = mic -, pin-5 = mic+].

4: Com Rtn TA3 Jack

Balanced connection for Com Return audio input. [pin-1 = Ground, pin-2 = hot (+), pin-3 = cold (-)].

5: Mic/Line Inputs 4-6 TA3 Jacks

Active-balanced analog microphone or line-level inputs. [pin-1 = ground, pin-2 = hot (+), pin 3 = cold (-)].

Right Side Panel



1: Antenna RP-SMA-Male Connector

Connects to included external antenna for Bluetooth LE.

2: 1/4" Headphone Jack

1/4-inch TRS headphone output. Warning! This output can drive headphones to potentially dangerous levels. [Sleeve = ground, tip = left, ring = right].

3: SD 1 and 2 Card Slots

Insert SD card media for recording. Insert label side down.

4: USB C Port

1. File transfer.
2. 2-in/2-out USB audio streaming

5: USB A Port

1. USB keyboard.
2. USB to SD-Remote Android app.
3. USB to the CL-16, CL-12, and approved 3rd party fader controllers.
4. Supports USB hubs.
5. Jam A20-Mini Timecode.

6: 10-18v DC TA4 Jack

Accepts DC voltages from 10–18 V for powering. [pin-1- GND, pin-2- Smart Battery DATA, pin-3- Smart Battery CLOCK, pin-4- +10-18 VDC].

7: Main Outputs L (AES 1,2), R (AES 3,4) XLR Jacks

Analog outputs on standard 3-pin XLR-3M connectors. Analog Output levels are selected between Line, -10, and Mic levels in Main menu > OUTPUTS. Can be set to send AES3 digital signals (1,2 and 3,4 on L and R respectively) in Main menu > OUTPUTS. Routing determined in the Outputs menu. [pin-1 = Ground; pin-2 = hot (+); pin-3 = cold (-). Unbalance by floating pin-3].

8: Aux In 3.5 mm Jack

Auxiliary input used for extra inputs or camera return [Sleeve = ground, tip = left, ring = right].

9: X3/X4 3.5 mm Jack

Unbalanced stereo 3.5 mm female connector. Routing determined in the Outputs menu. [Sleeve = ground, tip = X3, ring = X4].

10: X1/X2 TA3 Jacks

Line, -10, or Mic level selected in Main menu OUTPUTS section. Routing determined in the Outputs menu. [pin-1 = Ground, pin-2 = hot (+), pin-3 = cold (-). Float pin-3 to unbalance].

11: LTC/Wordclock/5-pin Lemo Jack

Timecode I/O, Wordclock. [pin-1- GND, pin-2- LTC or WORDCLOCK IN, pin-5- LTC or WORDCLOCK OUT (Pins 2 and 5 are software selectable)].

Rear Panel



1: Battery 1, Battery 2 Docking

Sony L-Mount type batteries may be used. When connected to an external DC source via DC the L-Mount batteries can be charged if enabled in the Power menu.

Top Panel



1: Expansion Port

Used for connecting A20-Nexus Multichannel Receiver, XL-AES 8 Channel AES3 Input Expander and SL-2 Dual SuperSlot Wireless Module.

Home Screen

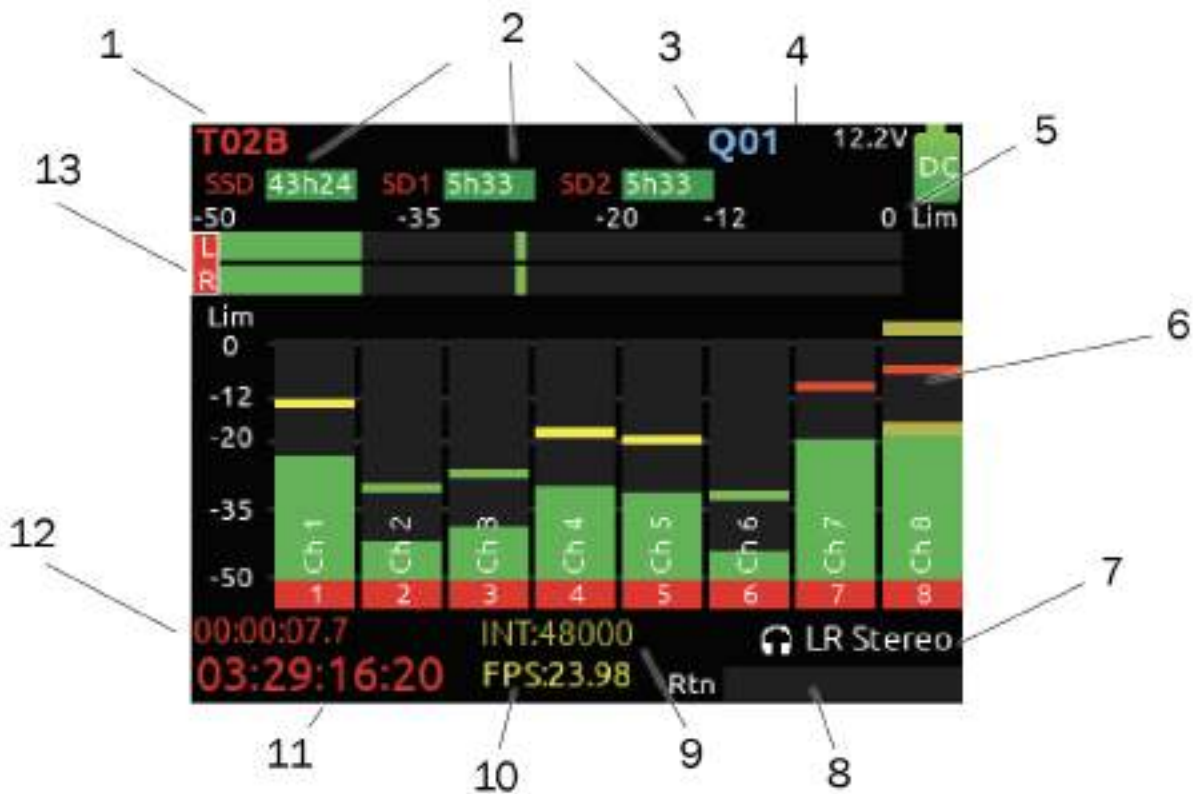

1: Current Take Name

Shows the filename of the currently-selected take. Press stop during stop to display the Next Take name. This Next Take display can be set to latching or momentary in the Record/Play menu. The latching option can be used with the Scene, Take, Notes 'Follow stop' toggle switch actions to quickly edit the metadata of the currently displayed take, whether it is Next or Current.

2: SSD, SD1, SD2

Indicates the amount of recording time available based on current track count, sample rate, and media routing. The internal SSD drive has a capacity of 256 GB.

3: Q-mark

Indicates Q-mark number.

4: Smart Battery Telemetry

Indicates time remaining and percent remaining of Smart Battery life. Other power sources will show voltage.

5: Power Icon

Indicates approximate voltage condition and current power source being used. When Smart Batteries are in use the remaining percentage and time is displayed.

6: Individual Channel Meters With Arm/Disarm Indication

Indicates the peak and VU audio levels of the individual channel. May be Pre- or Post- fade depending on Channel to Iso routing. The isolated track indicators turn red to indicate that the tracks are armed for record.

7: Selected Headphone Preset

Indicates the currently-selected headphone preset.

8: Return Meter

Indicates audio level for the return.

9 & 10: Sample Rate / Frame Rate/ Temporary Level Display

1. Indicates current sample rate.
2. Indicates current frame rate. Alternates with 32-bit float status when 32-bit float is enabled. See Track to Media Routing.
3. Temporarily indicates fader level of last moved fader (red text box).
4. Temporarily indicates trim level of last moved trim (green text box).
5. Temporarily indicates bus level of last adjusted bus fader (light blue text box).
6. Temporarily indicates output level of last adjusted out gain (white text box).
7. Temporarily indicates EQ freq and gain of last adjusted EQ (blue text box when EQ is On, orange text box when EQ is off or band is bypassed).

11: Timecode

Indicates current SMPTE timecode value in HH:MM:SS:FF.

12: File Elapsed / Remaining Time

Indicates in Hours:Minutes:Seconds:1/10ths the elapsed time of the current file. During playback, displays the elapsed and remaining time in hours, minutes and seconds.

13: LR Mix Bus Meters With Arm/Disarm Indication

Indicates the peak and VU audio levels of the L/R mix. The L and R indicators turn red to indicate that the tracks are armed for record.

Channel Screen



1: Channel Designation and User-Defined Name

Indicates the mixer channel designation and the user-defined channel name. Both are overlaid onto the channel audio meter. When in a Channel Screen, hold the PFL Switch for about 1 second to enter the virtual keyboard and enter a user-defined name for the channel. From this virtual keyboard, select Name on the Rtn toggle to access the Channel Name Manager from which you can create, edit, delete, insert, and replace channel names.



2: Channel Meter View

Indicates the audio level of the channel. Metering follows ISO Routing selection, Pre- or Post-fade.

3: Channel Trim Value

Indicates the gain of the channel trim control. The gain range depends on the type of input selected.

- Mic: -inf, +12 to +76 dB
- Line: -inf, -14 to +50 dB
- SL-2 (Rx): -inf, -20 to +50 dB
- SL-2 (AES): -inf, -20 to +50 dB
- SL-2 (A20 Transmitter GainForward): -inf, 0 to +60 dB
- A20-Nexus: -inf, -20 to +50 dB
- A20-Nexus (A20 Transmitter GainForward): -inf, 0 to +60 dB
- AES3: -inf, -20 to +50 dB
- AES42: -inf, 0 to +70 dB

- XL-AES: -inf, -20 to +50 dB
- Returns: -inf, -20 to +30 dB
- Channels 1-6 trim is adjustable using the front panel trim controls.
- Channels 7 & 8 trims are adjustable in the channel screen using the Select knob.

4: Channel Input Source Selection

Indicates which physical audio input source is feeding the channel. Sources can be changed during stop or record.



5: Channel Linking

Indicates the current linking status. The linking options are Unlinked, adjacent channels (eg. 1,2) and adjacent channels Mid Side (eg. 1-2MS). Linked parameters are: trims, faders, HPF, EQ, delay, limiter, mute, ISO, Bus Send 1 and Bus Send 2. Stereo panning is 1 to L and 2 to R. MS spread can be adjusted either in the odd channel's MS balance field by holding */** and rotating Select or by using the even channel's front panel trim pot. See Channel Setup menu. When unlinking from a stereo or MS pair, odd and even channel pans get set back to center.

6: HPF (High Pass Filter)

Indicates on/off status where green icon and white value = "On" and gray icon and value = "Off". The HPF frequency is variable in 10 Hz steps from 10 Hz to 320 Hz.

7: Polarity Reverse

Indicates polarity status. Green icon = polarity reversed, white icon = polarity normal.

8: Channel Input Delay

Indicates input delay time. The input delay is continuously-variable in milliseconds from 0-50 ms.

9: Channel Limiter

Indicates on/off status of channel limiter.

10: Channel Compressor

Compression, pre- or post-fade is available on channels 1-8 (1-12 with +4 plugin). Select to enter Channel Compressor screen.

Note: Compression can also be applied to Buses.

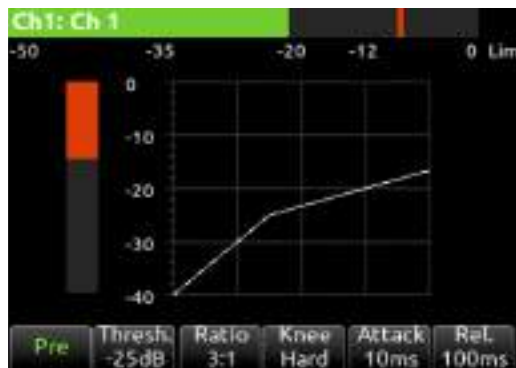

Mic Toggle

Selects Compression state and insert location. Indicates where the compression is inserted into the audio chain. Pre-fade or Post-fade [Off*, Pre, Post]. Compression applies to bus sends only when applied Prefade.

Tone Toggle

Selects threshold [0 to -40 dB]

* Toggle

Selects Ratio. [1.0:1 to 20:1 in 0.1 steps]

** Toggle

Selects Knee. [Hard, Soft]

Rtn Toggle

Selects Attack time [1 to 200 ms in 1 ms steps].

FAV Toggle Selects Release time [50 to 200 ms in 1 ms steps, 200 to 1000 ms in 10 ms steps]

11: Mute

Indicates mute status of channel. Blue icon = muted. Toggle mute on/off with the “Tone” switch.

12: L C R Select

Indicates the stereo pan position of the channel’s contribution to the L/R mix. Orange = selected. Use the */** switch to select. Hold */** switch and rotate Select knob for continuous panning positioning. Alternatively, press and hold Select knob, then use */** switch to pan continuously. Rotating the select knob while holding */** will change the balance of Mid, Center and Side when two channels are MS linked.

13: Arm

Toggle the Rtn/Fav switch to arm or disarm isolated track for recording.

14: Channel Copy

Channel Copy provides a mechanism for quickly copying multiple settings from one channel to other channels.

Select the Channel Copy icon to access the Copy Channel screen.

Choose which channels to apply the copied settings. Multiple destination channels can be selected. Then choose which settings to copy. Select any combination from EQ, HPF, Compressor, Limiter, Iso, Phase, Pan, Mute, Source, Name, Routing, Delay, and Arm. To copy, toggle the Fav switch.

**15: HP Preset**

Pressing the HP knob toggles between HP preset and PFL. Can be used to listen to channel panning while viewing the Channel Screen by setting the HP Preset to LR Stereo.

16: Channel To Bus Routing

Determines the bus or buses channel audio will be sent. When a channel is routed to a bus as a Send (bus box highlighted blue), the Send Gain value is used. When a channel is sent Pre-fade (green) or Post-fade (orange), the Send Gain value is ignored.

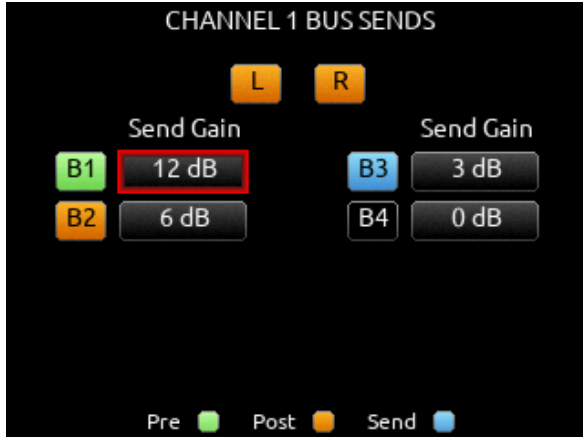

17: Noise Suppression (NA or NX)

Indicates whether the channel is selected for Sound Devices NoiseAssist (NA) or CEDAR sdnx (NX) and how much is applied. Field is grayed out when the Noise Suppression is disabled. White '--' (dashes) when Noise Suppression is enabled but channel not selected; white 'dB' value when channel is selected. NoiseAssist and CEDAR sdnx are optional paid PLUGINS.

18: Automix

Indicates whether the channel is selected for automixing. Purple text = On and white text = Off.

19: Channel EQ

3-band parametric EQ, pre- or post-fade is available on channels 1-8 (1-12 with +4 plugin). Select to enter the Channel EQ screen which displays the EQ settings as an EQ curve. The channel's HPF setting is also displayed as a blue circle here.



Mic Toggle

Selects EQ state and insert location. Indicates where the EQ is inserted into the audio chain. Pre-fade or Post-fade [Off*, Pre, Post]. EQ will apply to bus sends only when applied Pre-fade.

Tone Toggle

Selects EQ band mode [Bypass*, Active]

*/** Toggle

Selects EQ band. Use Select encoder to adjust frequency and HP encoder to adjust gain of the filter. [LF*, MF, HF] All filters are sweepable from 20 Hz to 20 kHz.

RTN Toggle

Selects Q (bandwidth) of selected band [0.5 - 10] (use Sel or HP knob to adjust).

FAV Toggle

Toggles filter type of LF and HF band [Peak, Shelf*].

20: ISO (channel->ISO) Routing

Indicates where the isolated track's audio is tapped from in the audio chain. Pre- or Post-fade. Post-fade is not available when 32-bit float is enabled.

21: Channel Fader Value

Indicates the level of the channel fader control, continuously-variable from -inf to +16dB. Channels 1-6 fader is adjustable using the front panel fader controls. Channels 7 & 8 faders are adjustable in the channel screen using the Select knob.

Virtual Keyboard

The virtual keyboard appears when alphanumeric text is to be entered or selected for editing. For example, Channel Names, Scene Names, Notes etc. The table below defines how the various toggle actions below the LCD are used with the virtual keyboard.

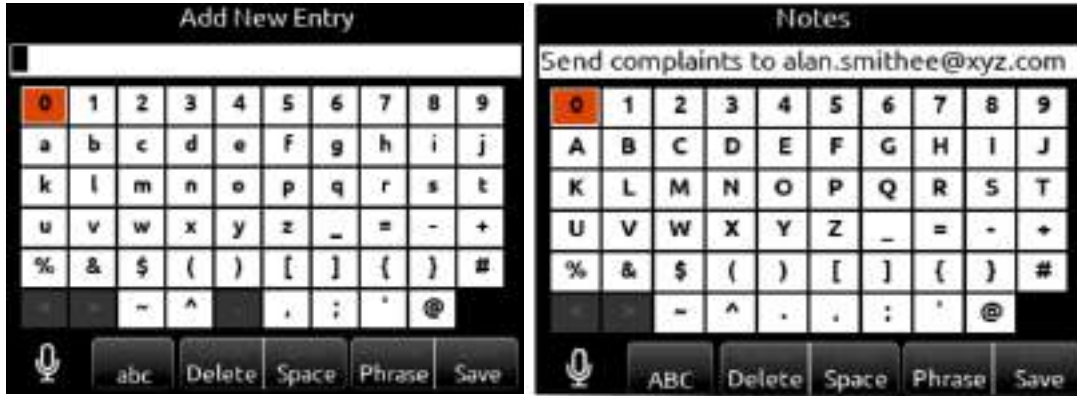

Action	Function
Rotate HP	Scrolls orange highlight through the keyboard characters.
Press HP	Inserts the highlighted character in text field.
'abc' switch	Quick flick toggles between A-Z and a-z in keyboard.
Hold 'abc' switch	Momentary selection of other case.
Delete	Deletes character to the left of flashing cursor.
Hold Delete	Repeatedly deletes characters to the left of flashing cursor.
Space	Inserts space at the flashing cursor position.
Hold Space	Repeatedly inserts spaces.
Save switch	Saves text and exits screen.
Rotate Select	Moves the cursor to the left or right in the text field.
Quick Press Select	Switches to the Shifted functions: Clear, End, Home, Exit. When shifted functions are active, their text changes to white and the non-shifted functions change to gray.
Clear	Clears text from the text edit field.
End/Home	Moves cursor to end/start of text.
Exit	Exits screen without saving text edits.

Phrase Manager

Phrases entered in the Phrase Manager are available in all virtual keyboard text editing screens such as scene names, channel names, notes, SD Card volume label etc.

Clear

Clears all phrases.

Delete

Deletes selected phrases.

New

Creates a new phrase.

Edit

Edits the selected phrase.

Insert

Inserts selected phrase into text.

Replace

Replaces text with current selected phrase.

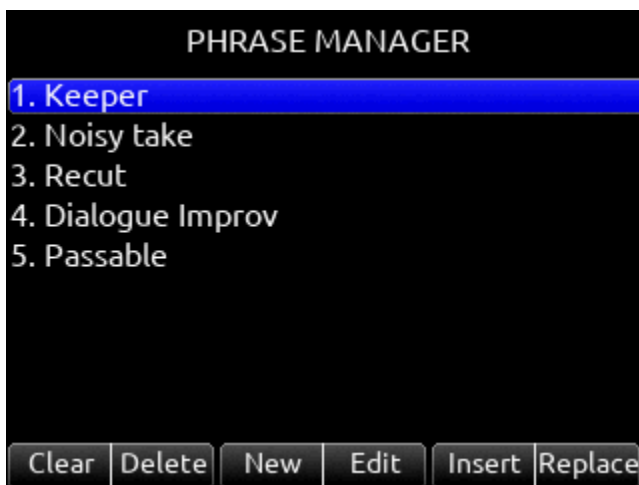

Menus

Main Menu

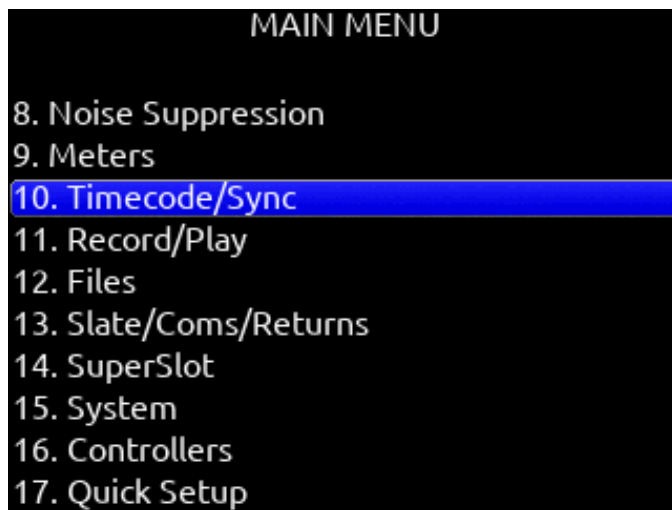
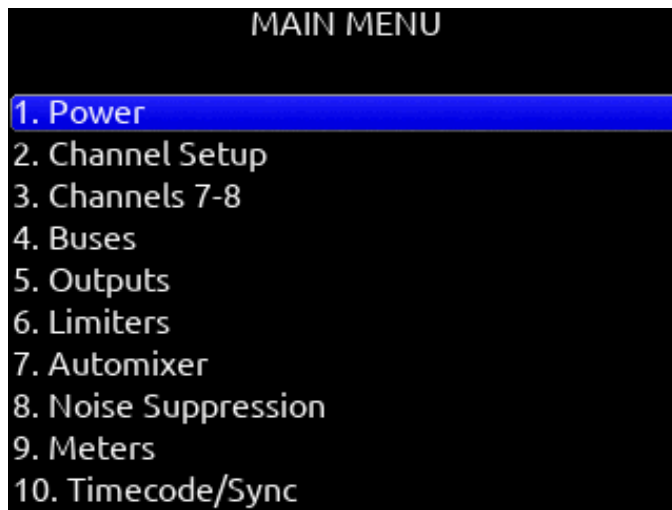

Power

Allows configuration of various power settings.

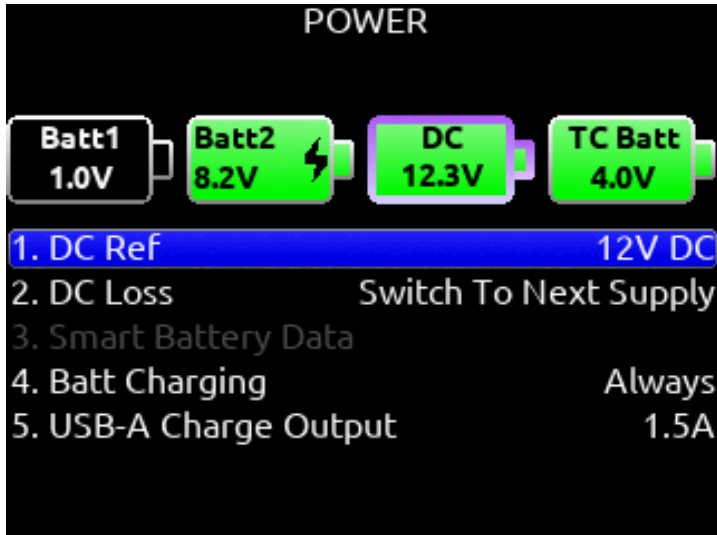

Power Source Icons

(Batt1, Batt2, DC, TC Batt,) Indicates the power condition of each power source. [Green = normal, yellow = below normal, red = warning]

DC Ref

Allows proper power level indicator calibration based upon the type of DC power source used. [12V DC*, 14 V Li-Ion, 12 V Lead Acid, Full Range (10-18 V), Smart Battery], NP1 Data

Power Source	Good	Marginal	Low	Shutdown
DC 12 V	12.50 V	11.00 V	10.10 V	9.50 V
Li-Ion 14 V	16.30 V	13.90 V	13.60 V	11.50 V
Lead Acid 12 V	14.00 V	11.50 V	10.30 V	10.20 V
Full Range	18.00 V	12.00 V	10.20 V	9.50 V
Smart Battery	16.00 V	13.50 V	12.60 V	10.75 V
NP1 Data Battery	16.30 V	13.90 V	13.60 V	11.50 V
Li-Ion L-Mounts	8.30 V	7.10 V	6.95 V	6.80 V

DC Loss

Selects how the unit should operate when DC power is lost. [Switch to Next Supply*, Turn Off].

Smart Battery Data

Displays Time Remaining, Percent Remaining, Cycle Count, and Temperature of Smart Battery.
Note: This menu is only displayed when a smart battery is connected.

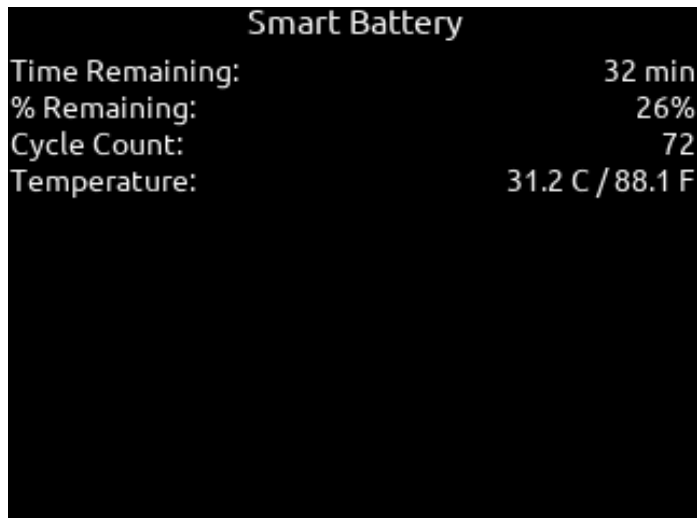
**Batt Charging**

Selects Sony L-Mount battery charging mode when connected to an external DC source. [Disabled, When Power Off, When Power On, Always*].

USB-A Charge Port

Allows charging of compatible external USB devices such as Android tablets [500 mA or 1.5 A*].

Channel Setup

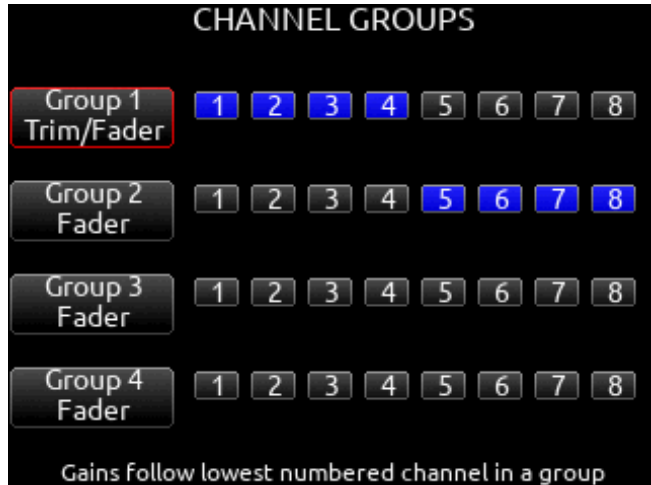

- 1. Phantom Voltage**
Selects phantom power voltage for all inputs. [12 V, 48 V*].
- 2. PFL Mode**
Selects the source of the PFL feed. [Auto* Pre-fade, Post-fade] Auto = pre-fade if channel is routed to ISO track pre-fade, post-fade if channel is routed to the ISO track post-fade.
- 3. Channel Grouping**
Channel Groups can be set to Off, Mute/Arm, Trim/Fader, or Fader. Groups allow the lowest channel number in the group to act as master control.
 - Off: Group disabled. Groups that are Off retain their channel routings but settings and levels are independent per channel. This allows for quick enabling or disabling of a group without losing group routings.
 - Mute/Arm: Only channel mutes and arms are grouped.
 - Trim/Fader: Trim, fader, record arming, limiters, and mutes are grouped. Trims can only be grouped when all channels of the group share the same gain range. Gain ranges depend on input type routed to a channel. See Channel Screen>Channel Trim Value for more detail.
 - Fader: Fader groups act just like Trim/Fader groups but trims remain independent per channel.

Four channel groups are possible; channels grouped can only be assigned to one group.

- a. Group 1 [1-8]
- b. Group 2 [1-8]
- c. Group 3 [1-8]
- d. Group 4 [1-8]

Note: When the optional +4 Plugin is installed, channels 1-12 are available for grouping.

4. PFL Gain

A preset amount of gain that is applied to any channel(s) with active PFL.

5. MS Spread Control

Selects how the MS spread is controlled when a pair of channels are MS-linked. [PFL Screen, Even Trim Pot]. PFL Screen = MS spread controlled by holding the odd channel's PFL screen */** toggle and rotating Select. Even Trim Pot = MS spread controlled by rotating the front panel's even trim pot.

6. Use Wireless Names (only when A20-Nexus is docked)

When A20-Nexus is attached using the A20-QuickDock accessory, the Use Wireless Names option enables the A20-Nexus transmitter/receiver channel names to be rippled directly to the 8-Series channels that they are routed to. This feature is also available for the SL-2. See SL-2 Options for more information.

Channels 7-8

When the optional +4 Plugin is installed, this menu is titled Channels 7-12. Provides access to channel screens 7-8 or 7-12 with +4 Plugin installed.

Access to channel screens is also possible by using the */** + PFL switch shortcuts:

- * + PFL 1 = Ch 7
- * + PFL 2 = Ch 8
- * + PFL 3 = Ch 9 (with +4 Plugin)
- * + PFL 4 = Ch 10 (with +4 Plugin)
- * + PFL 5 = Ch 11 (with +4 Plugin)
- * + PFL 6 = Ch 12 (with +4 Plugin)

Trims, Faders and PFL's for channel's 7 and 8 (or 7-12 with the +4 Plugin) can be controlled by a combination of the toggle switches beneath the LCD and the Select and HP Knobs. Setup in the System>Toggle Switch Action menu. See the Toggle Switch Action section for information on which of the following options are available for each toggle switch:

Ch 7 or 8 Trim/PFL (latch)

Flick toggle then rotate Select to adjust ch 7 or 8 trim. Gain values are displayed in the Home Screen sample rate field. Press Select to PFL. Flick toggle to cancel mode.

Ch 7 or 8 Fader/PFL (latch)

Flick toggle then rotate Select to adjust ch 7 or 8 fader. Gain values are displayed in the Home Screen sample rate field. Flick toggle to cancel mode.

Ch 7 Trim/PFL (Moment)

Hold toggle then rotate Select to adjust ch 7 trim. Gain values are displayed in the Home Screen sample rate field. Press Select to PFL.

Ch 8 Trim/PFL (Moment)

Hold toggle then rotate HP to adjust ch 8 trim. Gain values are displayed in the Home Screen sample rate field. Press HP to PFL.

Ch 7 Fader/PFL (Moment)

Hold toggle then rotate Select to adjust ch 7 fader. Gain values are displayed in the Home Screen sample rate field. Press Select to PFL.

Ch 8 Fader/PFL (Moment)

Hold toggle then rotate HP to adjust ch 8 fader. Gain values are displayed in the Home Screen sample rate field. Press HP to PFL.

Buses

Selects routing for Buses L,R and 1-4. Access buses via Menu > Buses or by holding Select and toggling a PFL switch.

When a bus screen is entered, that bus is solo'd by default in both HP L and HP R. If the bus is linked, the odd bus will be heard in HP L and the even bus in HP R. Toggle between Solo and the current HP preset by pressing the HP encoder.

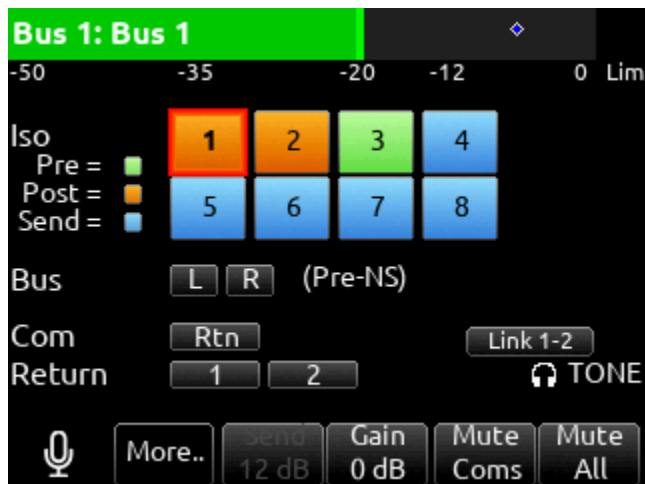

- 1. Bus Meter**
Audio level meter for the selected bus.
- 2. Link *-***
Selects linking for two odd-to-even numbered adjacent buses. Links bus Gain, bus limiters, Mute Coms, and Mute All functions.
- 3. ISO**
Any ISO channel contributes to Bus mix. Green fill in text box = Pre-fade, Orange fill in text box = Post-fade, Light Blue fill in text box = Send gain] Send adjusts the Iso channel send gain to the bus when the selected Iso channel is routed as a 'Send' to that bus (light blue fill in text box). When the selected Iso channel is set to 'Send' (light blue fill), enter the Send field with the * toggle then adjust send gain by rotating the HP knob.

Tip: Recorded ISOs can be played back via buses. This is useful for playing back alternate ISO mixes on set. By routing the ISOs as bus sends instead of pre or post-fader, you can adjust the ISO mix on playback. Use Buses B3-B4 for this purpose since Bus L, R, B1, and B2 can be recorded and are reserved for playing back their own recorded audio.

4. **Bus**
L,R, 1,2 (available on buses 3-4).
5. **Com**
Rtn (not available on L,R buses).
6. **Return**
Rtn 1-2 (not available on L,R buses)
7. **Slate**
Activates the slate mic. Slate mic will follow settings from Slate/Coms>Returns menu.
8. **More..**
Select to bring up a second page of Bus toggle switch functions including:
 - Name:** Select to name the bus
 - NoiseAssist (NA) or Cedar SDNX (NX)** In Bus 1-4 screens, use ** toggle to adjust the amount of NoiseAssist or CEDAR sdnx applied to the selected bus.
 - Bus Compressor (Comp):** Select Rtn toggle to set compressor parameters for the selected bus. Available bus compressor parameters:
 - Mic Toggle:** Selects Compression On or Off.
 - Tone:** Selects threshold [0 to -40 dB]
 - * Toggle:** Selects Ratio. [1.0:1 to 20:1 in 0.1 steps]
 - **Toggle:** Selects Knee. [Hard, Soft]
 - RTN Toggle:** Selects Attack time [1 to 200 ms in 1ms steps]
 - FAV Toggle:** Selects Release time [50 to 200 ms in 1 ms steps, 200 to 1000 ms in 10 ms steps] Limiter control.
 - Bus Limiter (Limit):** Select Fav toggle to toggle Limiter On or Off.
9. **Send (Bus Send on Fader)**
Channel Bus Sends in Bus screens. Use the Sel knob to navigate through the Bus send routing. When an ISO set to Send (highlighted in light blue) is selected, activate the * toggle then rotate the HP knob to adjust the gain of the ISO sent to the bus. Toggle the * switch again to exit Bus Sends on Faders.
10. **NoiseAssist (NA) or Cedar SDNX (NX)** In Bus L and R screens, use ** toggle to adjust the amount of NoiseAssist or CEDAR sdnx applied to the selected bus.
11. **Gain**
Use ** toggle to select and adjust selected bus gain in 1 dB increments. [Off-16 dB]
12. **Mute Coms**
Selects muting of Coms 1, 2 sends and returns.
13. **Mute All**
Indicates mute status of bus. Blue icon = muted. Toggle Mute All On/Off with the "Fav" toggle.

Outputs

LR, X1-X4 Output Routing

Selects routing for L,R and X1-X4 outputs [L Out, R Out, X1, X2, X3, and X4 Out]

Note: Only a single source can be routed to an Output. If multiple sources need to be routed, use a Bus.

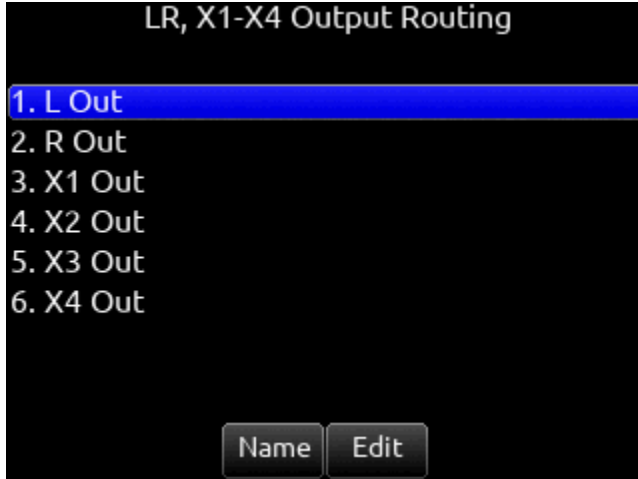

Name

Opens a keyboard for naming the selected Output. Output names appear in output meter views when a meter view preset has Track Names enabled.

Edit

Enters the Output screen. The bus can also be entered by pressing the Sel or HP knob.

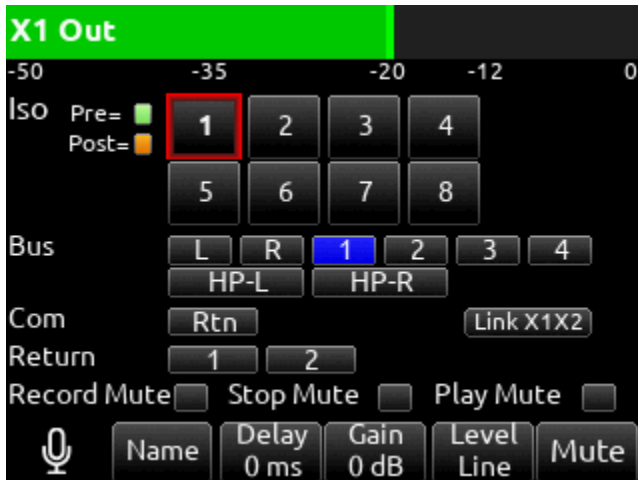

- 1. ISO**
Selected source will contribute to the Output. (Green = Prefade, orange = Post-fade [1-8])
- 2. Bus**
[L,R, 1-4, HP-L, HP-R]
- 3. Com**
Routes Com Return directly to the output.
- 4. Return**
Routes Return 1 or 2 directly to the output.

5. **Record Mute**
Selects automatic muting of the output when in Record mode. [Off*, On]. When an output is auto-muted, you can still mute/unmute manually.
6. **Stop Mute**
Selects automatic muting of the output when in Stop mode. [Off*, On]. When an output is auto-muted, you can still mute/unmute manually.
7. **Play Mute**
Selects automatic muting of the output when in Play mode. [Off*, On]. When an output is auto-muted, you can still mute/unmute manually.
8. **Delay**
The output delay is continuously-variable in milliseconds from 0-500 ms.
9. **Gain**
Selects amount of attenuation applied to the output. Toggle the ** to select [0 dB to -50 dB and -inf]
10. **Level**
Selects output level type. [Line, -10, Mic, AES] AES is available for L and R Outputs, AES is not available on X1-X4. See AES Output for more information.
11. **Mute**
Indicates mute status of output (Orange = muted) Toggle Mute On/Off with the "Fav" toggle.
12. **Link**
- Selects linking for two even-to-odd numbered adjacent outputs. Links gain, mutes, and delays.

USB

1. **ISO**
Any source selected will be routed to the selected USB output. (Green fill in text box = Pre-fade, Orange fill in text box = Post-fade [1-8])
2. **BUS**
[L,R, 1-4]
3. **Output**
All sources are selected post-delay. [L,R, X1-X4]
4. **Record Mute**
Selects automatic muting of the output when in Record mode. [Off*, On]. When an output is auto-muted, you can still mute/unmute manually.
5. **Stop Mute**
Selects automatic muting of the output when in Stop mode. [Off*, On]. When an output is auto-muted, you can still mute/unmute manually.
6. **Play Mute**
Selects automatic muting of the output when in Play mode. [Off*, On]. When an output is auto-muted, you can still mute/unmute manually.

AES Output



Selecting AES as the Level for L or R Outputs accesses the AES Output Routing menus. L Output is used to output AES 1 and 2. R Output is used to output AES 3 and 4.

From the AES Output Routing menus, route any bus to any AES Output using the Select knob.

Change Level back to Line, -10, or Mic to cancel AES Output and return to the L and R Output menus.

Playback Outputs

Selects whether playback should go to all outputs or only the headphone output.

1. **All Outputs:** This is the default selection. During playback, all outputs that are sourced from an ISO or Bus (L,R,B1,B2) will playback the ISO or Bus recorded tracks if available. Outputs that are not sourced from an ISO or Bus recorded track will be silent.
2. **Headphones Only:** During playback, headphone outputs, HP-L and HP-R will playback the recorded tracks selected in the 'Play' tab of the HP Preset 1-12 routing views.* All other outputs (LR, X1-X4, USB) will output live audio from the sources selected in their output routing pages.

Note:

- For each User HP Preset, up to four different recorded tracks can be selected for playback to the headphone outputs.
- In Headphones Only Mode, channel metering and PFLs monitor live input audio signals during playback. To meter and PFL recorded tracks, switch Playback Outputs to All Outputs Mode.
- Tip: Set any of Outputs X1-X10 to HP-L and HP-R, then monitor a Meter view that displays those outputs.
- When PFL'ing any channel during playback, the PFL'd channel is mixed with the selected HP Preset signal.

HP Presets

Select from factory HP Presets (items 1-6) or user-configurable HP Presets (1-12).

User HP Presets 1-12 can be custom-named and have their routing freely configured. User HP Presets have different routing options depending on whether Outputs>Playback Outputs menu is set to 'All Outputs' or 'Headphones Only'.



Function	Description
Name	Displays virtual keyboard and allows for naming of the headphone preset.
Edit	<p>Allows selection of routed sources to both HP Left and HP Right. Select HP LEFT or RIGHT and then select desired source.</p> <p>When Outputs>Playback Outputs = Headphones Only, the headphone routing splits into two routing tabs, one for Record,Stop transport modes (* toggle) and one for Play transport mode (** toggle).</p> <p>Select the desired sources for each transport mode.</p> <p>To select or deselect an ISO track or bus track for playback in the 'Play' routing tab, select the ISO or Bus and press and hold the encoder knob for > 1 sec. When the track is enabled for playback, the routing cell color is pink.</p> <ul style="list-style-type: none"> • ISO- [1-8] Any source selected will be routed to the selected HP output. Green = Pre-fade, orange = Post-fade. , pink = track ('Play' routing tab only). • Bus- [L,R, 1-4] • Com- [Rtn] • Return- [1, 2]
Mono	Selects monophonic monitoring of selected HP-L/HP-R sources.
MS	Applies MS decoding to the selected HP-L/HP-R preset sources.
Unlist	Deselects a preset in the list preventing it from being listed in the HP Preset menu (press HP knob on Home Screen).
List	Selects a preset in the list allowing it to be listed in the HP Preset menu (press HP knob on Home Screen).
Fav	Selects a favorite preset. The name turns green when selected. The "Fav" switch recalls this HP preset when in the Home Screen.

Limiters

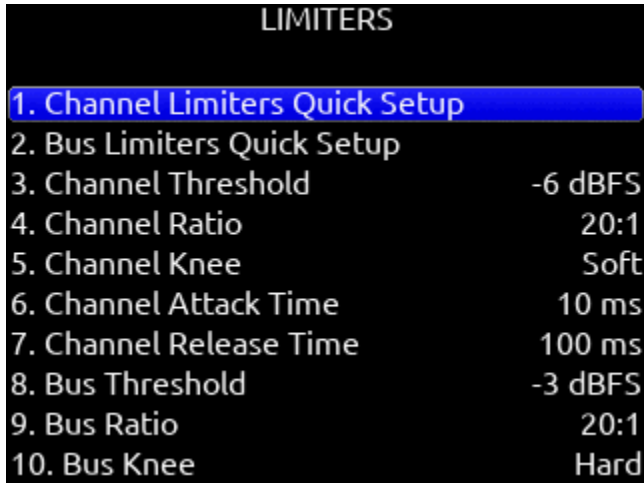

LIMITERS	
1. Channel Limiters Quick Setup	
2. Bus Limiters Quick Setup	
3. Channel Threshold	-6 dBFS
4. Channel Ratio	20:1
5. Channel Knee	Soft
6. Channel Attack Time	10 ms
7. Channel Release Time	100 ms
8. Bus Threshold	-3 dBFS
9. Bus Ratio	20:1
10. Bus Knee	Hard

Channel Limiters Quick Setup

Selects the channel limiters on/off status globally. [All On*, All Off]

Bus Limiters Quick Setup

Selects the bus limiters on/off status globally. On*, Off]

Channel Threshold

Selects the threshold at which the channel limiters activate. -6 dBFS* [-2 to -12 dBFS]

Channel Ratio

Selects the ratio of the limiter. [Inf:1, 10:1, 12:1, 14:1, 16:1, 18:1, 20:1*]

Channel Knee

Selects the channel limiter Knee. [Hard, Soft]

Channel Attack Time

Selects the channel limiter attack time [1*-200 ms]

Channel Release Time

Selects the release time of the limiters in 10 ms increments. 100 ms* [50-1000 ms]

Bus Threshold

Selects the threshold at which the bus limiters activate. -3 dBFS* [-2 to -12 dBFS]

Bus Ratio

Selects the ratio of the limiter. [Inf:1, 10:1, 12:1, 14:1, 16:1, 18:1, 20:1*]

Bus Knee

Selects the bus limiter Knee. [Hard, Soft]

Bus Attack

Selects the bus limiter attack

Bus Release Time

Selects the release time of the limiters in 10 ms increments. 100 ms* [50-1000 ms]

Automixer

Selects the Automixing mode and the channels included in the auto mixer group(s).

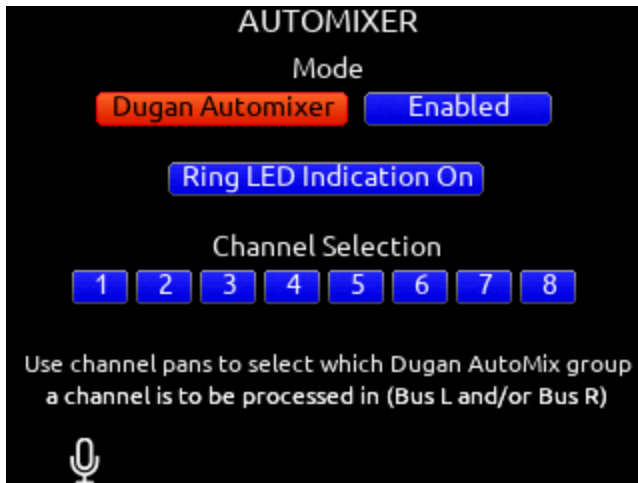

Mode

Selects the Mode of Automix [MixAssist, Dugan Automixer] and whether it is disabled* or enabled.

Note: Set a toggle shortcut or mapped controller button to enable/disable the selected automixer mode to allow you to quickly compare the effect of the automixer being on or off.

Ring LED Indication

Set to On to display automix meter levels on the ring LEDs. Set to Off if you prefer to only see automix levels in the LCD meter views.

Channel Selection

Selects which of channels 1-8 are included into the automix group(s). A channel can also be selected for automix from channel screens 1-8. Enter a channel screen 1-8 then use the Select knob to scroll to and toggle the Automix on or off for that channel. Purple text is On, white text is Off.

Note: If a channel is enabled for automixing, it sets post-fade routing of that channel to Bus L and R in the Channel Bus Sends menu and the Bus L and R routing menus. Channels can still be unrouted or routed pre-fade to Bus L and R but note that automixing only applies to post-fade channels.

Note: Automixer is only available with sample rates of 47952, 48000, and 48048 Hz.

Dugan Automixer Mode

Dugan gain display bars is overlaid on top of the channel signal meters. The top 15 dB of the meter scale is shared between Dugan gain display bars and audio signal metering. Dugan gain display bars range from 0 dB (at the top, aligned with 0 dBFS, no attenuation) to -15 dB (max attenuation). The -15 dB value is indicated by a purple horizontal graticule mark near the top of a channel's signal meter when that channel is enabled for Dugan in Menu>Automixer.

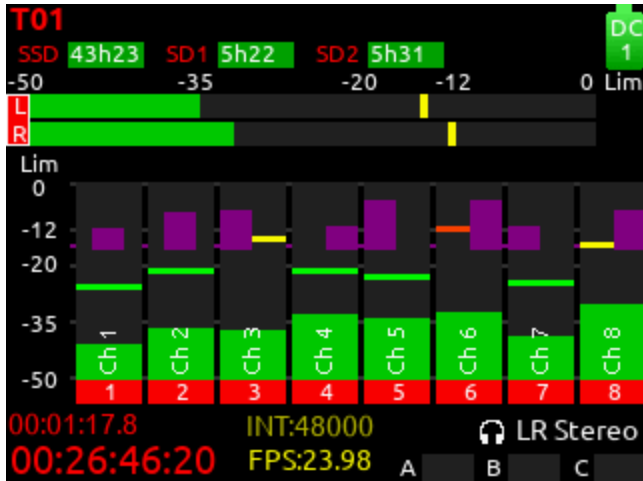

There are two independent Dugan processing groups, Bus L and Bus R. Channels 1-8 can be routed to Bus L, Bus R, both equally (Center), or both unequally (L or R pan increments) by using a channel's pan control.

To show which Dugan group the channel is in, the Dugan gain display bar is left-aligned for fully L, right-aligned for fully R and center-aligned for any other pan value. When a channel is routed to both Dugan groups (Bus L and R), the center-aligned meter bar shows the least attenuated value.

The Channel Screen shows the Dugan meter overlaid within the horizontal channel meter. The Dugan meter scale and indication is the same as in the main meter screen.

The ring LEDs for ch 1-6 show Dugan gain for ch 1-6. The ring LEDs begin to glow purple at 15 dB attenuation and increase in intensity at 0 dB attenuation.



MixAssist Mode

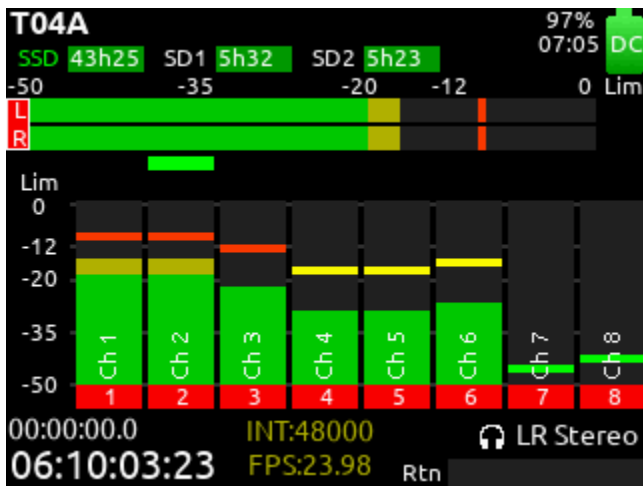

MixAssist Off-Attenuation

Sets the amount of attenuation applied to inactive input channels. Range: 6 dB to 40 dB. Default: 15 dB.

When a channel is active (not attenuated), its ring LED (channels 1-6 only) and LCD meter view channel indication illuminate green.

There are two independent MixAssist processing groups, Bus L and Bus R. Channels 1-8 can be routed to Bus L, Bus R, both equally (Center), or both unequally (L or R pan increments) by using a channel's pan control.

Meters

Selected Preset

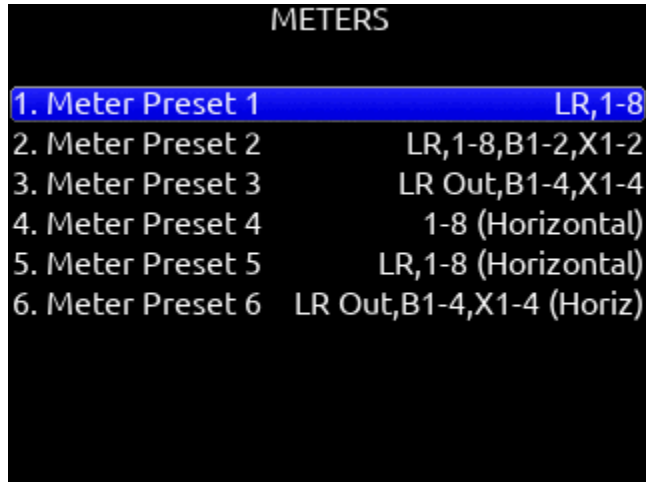

METERS	
1. Meter Preset 1	LR,1-8
2. Meter Preset 2	LR,1-8,B1-2,X1-2
3. Meter Preset 3	LR Out,B1-4,X1-4
4. Meter Preset 4	1-8 (Horizontal)
5. Meter Preset 5	LR,1-8 (Horizontal)
6. Meter Preset 6	LR Out,B1-4,X1-4 (Horiz)

Meter Presets 1-6

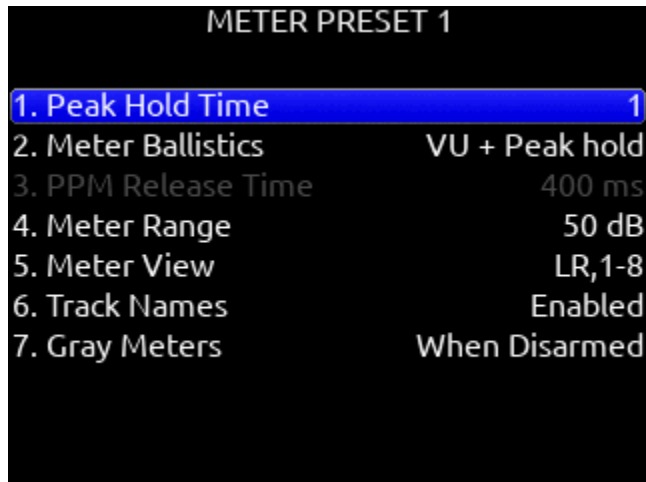

METER PRESET 1	
1. Peak Hold Time	1
2. Meter Ballistics	VU + Peak hold
3. PPM Release Time	400 ms
4. Meter Range	50 dB
5. Meter View	LR,1-8
6. Track Names	Enabled
7. Gray Meters	When Disarmed

Peak Hold

Time Selects the peak hold time for the meter preset. [Off, 1*-5s., Infinity]

Meter Ballistics

Selects the ballistics for the meter preset.

VU: The meter bar ballistics emulate the 300 ms attack and 300 ms release times of a VU meter. VU meter ballistics correspond closely to how the human ear perceives loudness. This provides a good visual indication of how loud a signal will be.

VU + Peak Hold: Same as the VU setting but with the addition of a peak hold segment. See Peak Hold Time above.

PPM: The meter bar ballistics have instantaneous attack time and slow release time. Ideal for monitoring actual signal peaks. The release time can be set using the PPM Release Time setting.

PPM + Peak Hold: Same as the PPM setting but with the addition of a peak hold segment. See Peak Hold Time above.

PPM Release Time

Selects the Release Time for the PPM meter ballistics. [400 ms* to 1600 ms in 200 ms steps]

Meter Range

Selects the range of the meters from bottom to top of scale. [50 dB*, 40 dB, 20 dB]. When in a meter view, press and hold Meter while rotating HP knob to adjust the meter scale on the fly.

Meter View

Selects the meters to be viewed in the current preset. [LR,1-8*, LR 1-8,B1-2,X1-2, LR Out B1-4,X1-4, 1-8 (Horizontal), LR,1-8 (Horizontal), LR Out,B1-4,X1-4(Horiz), LR,1-3 (Horizontal), LR,1-12 (with +4 Plugin), LR>Returns]

Track Names

Selects whether track name, output name, and bus name are displayed in the meter preset. [Enabled*, Disabled]

Gray Meters

Selects gray meter when record track is disarmed. [When disarmed*,Off]

SL-2 Receiver Overview

Selects the Peak Hold Time and Meter range for the SL-2 Receiver Overview audio level meters. Ballistics and PPM release time are taken from the last selected Meter Preset. Menu not available unless an SL-2 is connected.

Meter View Menu Shortcuts



When in LR, Outputs and LR, and Buses Meter Views, turn the Select knob to scroll to an output or bus. Pressing the Select knob acts as a shortcut to that outputs or bus routing screen. Pressing the Select knob acts as a shortcut to that outputs or bus routing screen.

Timecode

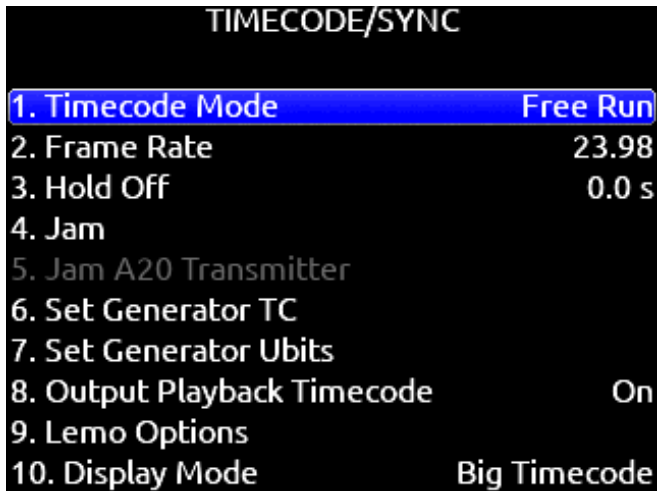

Timecode Mode

Selects the timecode mode of operation. [Off, Record Run, Free Run*, Free Run Auto Mute, Free Run Jam Once, 24 Hour Run (ToD), 24 Hour Run Auto Mute, Ext TC, Ext TC - Auto Record, Ext TC Continuous, Ext TC Cont. - Auto Record]

Frame Rate

Selects the current frame rate. [23.98*, 24, 25, 29.97 ND, 29.97 DF, 30 ND, 30 DF]

Hold Off

Selects the amount of time incoming timecode needs to be valid prior to entering record when in auto-record mode. [0.0*-8.0 seconds in steps of 0.1 sec]

Jam

Indicates the Received TC, Generator TC and the calculated difference between the two. Received and Generator UBits are shown. Jamming to external TC and UBits is supported.

Jam TC- Toggle Rtn/Fav switch to jam to external TC.

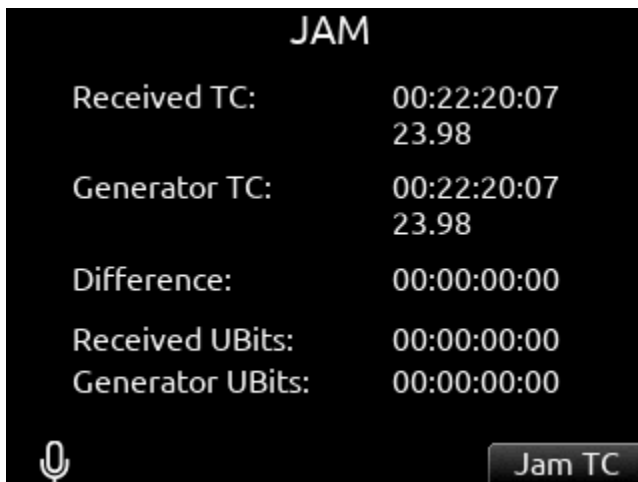

Jam A20 Transmitter

This menu is normally grayed out. It is only available when an A20 transmitter is connected via USB-A to the Scorpio. Displays the timecode and frame rate of Scorpio and A20 transmitter along with the calculated difference.

Toggle the Jam A20- Rtn/Fav switch to jam the A20 transmitter. (Picture shows screen for 8-series model 888)



Set Generator TC

Provides the ability to start rolling internal TC from a manually entered value in the format of HH:MM:SS:ff.

Set Generator UBits

Provides UBits manual and automatic entry. [U=User entered UU:UU:UU:UU*, mm:dd:yy:UU, dd:mm:yy:UU, Use External] Use Rtn/Fav toggle to exit.

Output Playback Timecode

When set to On, the playback file's timecode is output from the Lemo connector. When Off, the live timecode continues to be output.

Lemo Options

Selects pin-2 and pin-5 options for TC Lemo connector.

1. Pin-2 - [TC In*, WCK In, WCK Out]
2. Pin-5 - [TC Out, WCK Out]

Display Mode

Selects whether to display Big Timecode or Big A-Time.

Sync Reference

Selects current sync reference for all transport modes (record, stop and play). [Internal*, Word Clock, LTC In, AES 1,2 (XLR 1)] Ring LEDs flash yellow while locking to the selected sync reference. Once locked, the LEDs will stop flashing. Should the LEDs flash indefinitely, the selected sync reference has not been detected. Locking can take up to 30 seconds.

Note: Expansion port accessory AES inputs cannot be used as a sync reference source.

Holding TC While Powered Down When a TA4 DC power source is not connected, the 833 holds timecode accurately for four hours before resetting, provided the internal timecode backup battery is charged. When a TA4 external battery is connected, timecode will continue counting indefinitely until the external battery drains. To prevent the external battery from draining, set Timecode Mode to Off.

The internal timecode battery charges when:

1. The 833 is on and powered by L-Mount batteries or the TA4 DC In.
2. The 833 is off, power is connected to the TA4 DC In, and the Power>Batt Charging option is set to Always or When Power is Off.

Record/Play

The 12-track 833 is capable of recording and playing back audio at up to 192 kHz sample rate with a fixed bit depth of 16-bit or 24-bit or a floating bit depth of 32-bit floating point at up to 96 KHz. This versatility allows the 833 to be used in a myriad of applications from dialog and voice recording, to live music recording, to sound FX capture.

Sample Rate

Selects the current sample rate. [44100, 47952, 48000*, 48048, 96000, 192000 Hz]



Bit Depth

The 833 has the ability to record:

- Fixed bit depth (16-bit, 24-bit) for ISO tracks or bus tracks (L, R, B1, B2).
- Floating point (32-bit) for ISO tracks. Bus tracks (L, R, B1, B2) cannot be recorded in 32-bit floating point.
- Combined fixed and floating point: 16-bit or 24-bit bus tracks along with 32-bit floating point ISO tracks.

Fixed bit depth is set in the Bit Depth menu. 32-bit floating point is enabled for ISO tracks in the Track to Media menu.

Why 32-bit Floating Point?

The key benefit of 32-bit floating point recording is the elimination of distortion due to digital overload/clipping i.e. signals that exceed 0 dBFS. It is an excellent technology for recording audio sources that have unpredictable level and wide dynamic range, everything from jet fly-overs to voices suddenly changing from a whisper to a scream.

32-bit Floating Point for Dialog Recording

In traditional dialog recording, analog limiters are frequently used to prevent digital overload when an actor unexpectedly shouts or screams. High quality analog limiters such as those in the 8-Series do a fantastic job of preventing digital overload distortion. However the fact remains that a limiter by its very nature, introduces distortion, albeit a more natural and acceptable distortion than the digital overload distortion it prevents. This is where 32-bit floating point comes in because it allows signal to exceed 0 dBFS without digital overload distortion. It provides a distortion-free alternative to using 24-bit with analog limiters for capturing unpredictable and wide dynamic range voice sources.

Although 24-bit fixed recordings have a dynamic range of ~144 dB (which is more than adequate for capturing the dynamic range of most audio sources), if source levels swing wildly and unpredictably from super quiet to super louds, it is challenging to know where to set microphone preamp trim gain levels. Production sound mixers typically set trim gain levels such that normal dialog levels are at -20 dBFS, peaking to around -12 dBFS allowing for a headroom of 12 dB for those occasional excessive loud sounds. Analog limiter thresholds are typically set at around -3 to -4 dBFS to prevent these excessive louds sounds from causing digital overload. The analog limiter distortion is much less offensive than digital overload distortion. To avoid overload distortion altogether in 24-bit recording, the sound mixer would have to work with a lot more headroom, possibly as much as 40 to 50 dB. However, delivering audio files at such a low nominal level could be problematic for post production workflows. With 32-bit floating point, you can deliver distortion-free audio files at normal levels.

Considerations when recording in 32-bit Floating Point with the 8-series

- Only ISO tracks can be recorded as 32-bit floating point wav files.
- Bus tracks (L, R, B1, B2) are always recorded as fixed 24 or 16-bit.
- A maximum of 2 media can be recorded to when operating in 32-bit floating point.
- Maximum sample rate is 96 KHz when operating in 32-bit floating point.

- 32-bit floating point ISO recorded tracks are unaffected by limiters, compression, EQ, noise suppression, and auto-mixing even if those processes are enabled. Channel limiting, compression, EQ, noise suppression, and auto-mixing only affect the ISO paths into the mix busses and outputs.
- 32-bit floating point ISO recorded tracks are affected by HPF, delay and polarity.
- When 32-bit floating point is enabled, only pre-fade ISO routing is allowed.
- When 32-bit floating point is enabled, the Home screen's frame rate field alternates with the bit-depth status every 3 seconds.
- 32-bit floating point is not permitted when AAC is enabled.

Recommendations when recording in 32-bit Floating Point.

- Although most modern NLEs and DAWs support 32-bit floating point wav files, it is recommended to liaise with post-production to ensure they meet their workflow criteria.
- Continue to gain stage as you normally would when recording 24-bit.
- It is recommended to enable limiters on ISO channels to prevent clipping in their pre and post fade paths into the fixed bit mix busses (L, R, B1, B2) and outputs. Even with limiters enabled, 32-bit floating point ISO tracks are still recorded limiter-free.
- **Warning:** the HP output may still clip when monitoring >0dBFS signals.

Pre-roll Time

Selects the amount of Pre-roll recording. Adjustable in 1 second increments. [0*-10 s.] Higher sampling rates reduce the maximum allowed Pre-roll, 2 seconds is available at 192 kHz.

Post-roll Time

Selects the amount of Post-roll recording. Adjustable in 1 second increments. [0*-10 s.] If a recording is stopped prematurely, press record within the post-roll time. The machine will continue to record into the original file. Useful for when directors call 'cut' prematurely. During the post roll period, the transport joystick ring LED shows orange. Pressing stop again during the post-roll period cancels the post roll and stops recording.

Stop Hold Time

Selects how long Stop must be pressed before record or playback stops. Useful for preventing accidental termination of recording or playback.

Track to Media Menu

Selects the sources for each recording media as well as the type of file recorded. Tracks may be routed to media to be recorded as AAC (LR or Bus 1,2 only), WAV Mono, or WAV Poly files. (Green text box= WAV Mono file, Blue text box= WAV Poly file, Orange text box = AAC)

ISOs can be set to record as 32-bit floating point wav files by activating the '32b Float' box. When activated, the LR and B1B2 mix tracks continue to be recorded at the bit depth selected in the Bit Depth field (item 2 in the Record/Play menu).

Note: 32b float option is not permitted in the following situations:

- If any of the the media (SSD, SD1, or SD2) are set to ALL
- If AAC is selected.

Track to Media Routing Examples

Record ALL armed tracks as polyphonic wav files to SSD, SD1, and SD2



Record ALL armed tracks as monophonic wav files to SSD, SD1, and SD2



Record ALL armed ISO tracks as 32-bit float polyphonic wav files to SSD and SD1



Record

1. Armed ISO tracks as monophonic 32-bit float wav files to SSD, SD1
2. Armed L/R mix tracks as polyphonic files to SSD and SD1

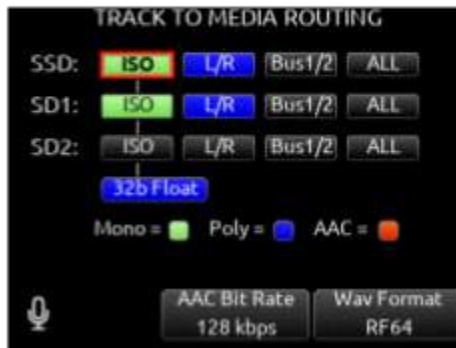

Select whether Mono or Poly WAV files are recorded in standard BWF or RF64 format using the Rtn/Fav toggle. BWF WAV files seamlessly auto-split to a new file when the max BWF 4GB file size is reached. Split files can be joined in any DAW. RF64 WAV files have a much higher maximum file size and do not require auto-splitting.

Note: Most DAWs support WAV RF64. Some NLEs do not. It is recommended to check NLE compatibility before using RF64. Also: 8-Series Q-marks are not supported when RF64 is selected.

Tracks L/R and Bus1/2 can also be recorded as AAC audio files. (Orange text box). AAC files are ideal for transcription. Select the AAC Bit Rate using the */** toggle switches. [32, 64, 128, 192, 256 kbps]

Select the WAV Format using the Rtn/Fav toggle switches. RF64 allows for WAV files larger than 4 GB.

- A. SSD- [ISO, L/R, Bus1/2, ALL]
- B. SD1- [ISO, L/R, Bus1/2, ALL]
- C. SD2- [ISO, L/R, Bus1/2, ALL]

To differentiate between the ISO and L/R mix poly files:
 "ISO" is appended to the end of the ISO poly file's filename.
 "LR" is appended to the end of an L/R poly file's filename.
 "B1B2" is appended to the end of a Bus 1/2 poly file's filename.

* Monophonic file recording up to 48.048 kHz. Monophonic files for each take are stored in their own Take Folder within the selected Record Folder.

** AAC file format when recording at 48 kHz.

Default Playback Drive

Selects the drive for playback. [SSD, SD1, SD2]

Next Take Display

Selects whether the Meter View's Next Take field is displayed momentarily whilst the stop button is held in or whether it latches on with a brief press. When set to Stop (Latching), Toggle Switch, Menu+PFL, or Controller Mapping shortcuts set to Scene (Follow Stop), Take (Follow Stop), or Notes (Follow Stop), the Scene, Take, Notes virtual keyboards edit the Current or Next take depending on whether the Current or Next take is displayed in the Meter View.

Playback Take/File From Take/File List

Enter the take or file list and select a take or file with either knob. Pressing play will playback the selected take or file.

Arming/Disarming During recording

All channels can be armed/disarmed while recording. This creates a seamless split to a new file or files. The split takes will be suffixed with an incrementing alphabetic character. i.e. A, B, C...

Auto-Split

Takes that are auto-split due to the 4 GB limit of BWF format are also suffixed using the same A, B, C...incrementation.

Record Split

Takes that are split when pressing record during recording increment the file's take number.

False Takes

Press HP + << to false take the last recording. This moves the last take to the FALSETAKES folder at the root of each drive and decrements the take number in preparation for the next take.

Q-marks

Use Q-marks, (also known as cue marks) to mark points of interest within a recording. Q-marks can be added and deleted during recording, playback, pause, or scrub mode when viewing the Home screen. Once added, they can easily be located to during playback on the 8-Series. Q-marks are also embedded in the WAV file and can be read by audio editing applications such as Reaper and Adobe Audition.

Note: Q-marks are only supported when using the BWF WAV format, not the RF64 WAV format.

Note: Q-marks in auto-split files (due to BWF 4GB max size) are not supported.

To add a Q-mark, hold Select and press >>.

The Q-mark number is displayed in blue at the top of the meter view to the right of the take name. Each time a new Q-mark is added, the Q-mark number is incremented. (Q01, Q02, Q03)

To delete a Q-mark, hold Select and press <<.

Q-marks can also be added and deleted using Toggle Switch Action shortcuts, Midi mapped buttons, and USB Keyboard buttons 'Q' and 'delete'.

Locating to Q-marks during playback, pause, or scrub:

To locate to the next Q-mark, press >>. If there is no next Q-mark, pressing >> will locate to the end of the take and will pause playback. To locate to the previous Q-mark, press <<. If there is no previous Q-mark, pressing << will locate to the beginning of the take.

Tip: To check the last few seconds or minutes of a long take, Press >> after the last Q-mark has been passed. This will pause playback at the end of the take. Then rewind or reverse scrub to the point of interest and press play.

Files

Take List

Enters the Take List. The Take List shows a running list of recorded takes in chronological order with most recent at the top. Various details of each take are indicated on the right side of the display: TC (timecode), Duration, Media, Folder, Scene, Take, Date, and Notes. From this list, takes may be selected for metadata editing by using the Rtn/Fav toggle or pressing the HP knob to access the Take Edit Menu.

Press Menu + HP knob as a shortcut to the Take List. Highlight any take in the Take List, then press play to play it back.

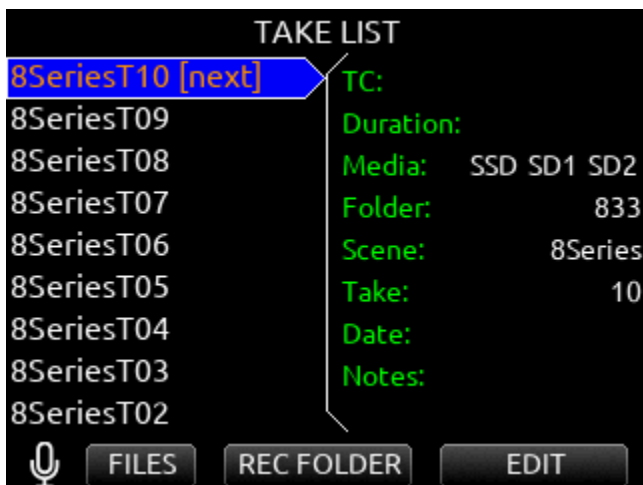
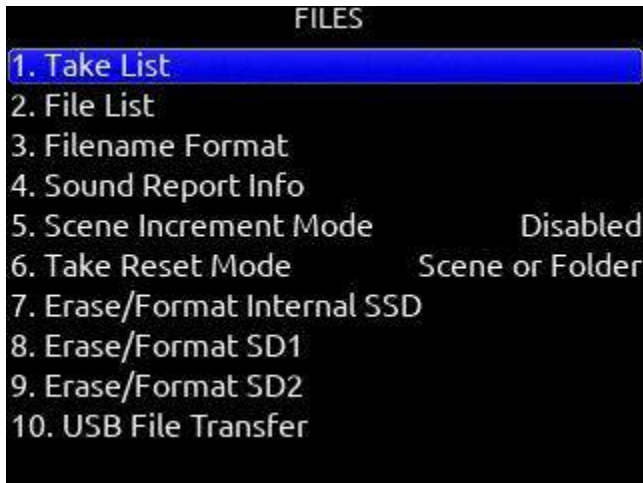

Record Folder

Record Folders are containers for storing recorded audio files and sound reports. They can be nested up to three levels deep. Set a record folder as 'current' to determine where audio files and sound reports are stored.

Record folders are unified across all three media (SSD, SD1, SD2) - any actions taken on a record folder (NEW, SET CURRENT, Rename Folder, Delete Folder, Create Sound Report) affect that record folder on all three media.

To select an existing record folder or to create a new record folder, go to the Take List and use the */** toggles to access the REC FOLDER menu. By default, the RECORD FOLDER menu displays a list of record folders at root. Navigate to nested folders by highlighting a record folder and pressing the Sel/HP knob. To navigate back up the folder hierarchy, press Menu or select "\.." at the top of the folder list. The screen's title identifies the folder path.

To create a new record folder in the folder level being viewed, select NEW (Tone toggle). The newly created record folder is automatically set as the current record folder. Select the Folder Type in the popup that appears. There are three types of record folder - Custom, Project, and Daily.

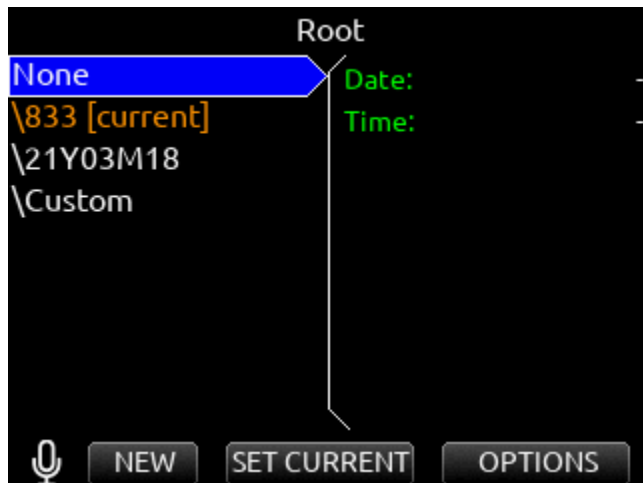

Custom

Files are stored in a custom-named folder; the Custom folder name is embedded as Tape metadata in the recorded audio files.

Project

Files are stored in a folder with a name determined by the Project name entered in the Take List > Next take Edit Screen. The Project folder name is embedded as Tape metadata.

Daily

Files are stored in a folder whose name is in the format yyYmmMdd. When a Daily folder is selected, the Date is embedded as Tape metadata.

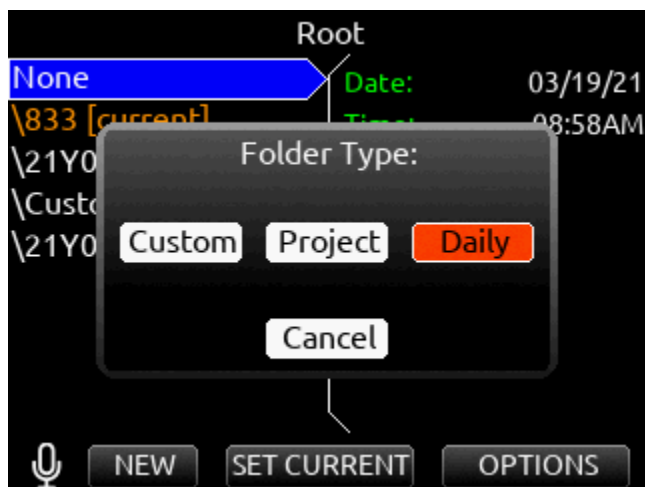

When a daily folder is selected as the current record folder, a daily folder popup is displayed when the first recording after midnight is completed. The daily folder popup displays the following message:

“Store this recording and subsequent recordings in the previous day’s folder or store in a new daily folder? [Previous], [New]”

- Select Previous to continue recording takes in the previous days folder.
- Select New to record in a new Daily folder.

Tip: To store new recordings in the root directory, highlight 'None' in the Root screen then select the */** toggle (SET Current). When 'None' is selected, the date is embedded as Tape metadata.

Any existing record folder can be set as the “current” record folder. Use the SET CURRENT *** toggle to set the highlighted folder as the “current” record folder. The current record folder can be easily identified by the orange “[current]” tag following the folder name.

Tip: To easily find the current record folder when it is nested within another folder, navigate the path indicated by orange record folder names.

Tip: The Record Folder menu can also be accessed by selecting ‘Folder’ from the Take List>Next Take Edit screen. This also shows the current record folder’s full path.

Tip: Program a Toggle Switch or map a shortcut for one-touch access to the Record Folder menu.

Record Folder Options

Highlight a record folder then select OPTIONS using the Rtn/Fav toggle. The following options are available:

Create Sound Report

Creates a sound report for the selected folder (not including its sub folders) on all 3 media. If there are no audio files in the selected folder, a ‘No Takes Found’ popup is displayed.

The sound report’s filename format is [Date]_[RecFolderName]_Media.CSV, where Date is a 6-digit string based on the Date Format setting in the System>Time/Date menu and Media = ‘_’ for SSD, ‘_1’ for SD1, and ‘_2’ for SD2.

For example: Rec Folder name = ROLL8, Date = 13th Aug, 2020 would appear as:

081320_ROLL8.csv (on SSD)

081320_ROLL8_1.csv (on SD1)

081320_ROLL8_2.csv (on SD2)

Rename Folder

Renames the selected record folder on all three media. This renames the actual folder, not the embedded Folder (Tape) metadata within .wav files that have already been recorded. A Daily Folder cannot be renamed.

Delete Folder

Permanently deletes the selected record folder and all its contents including sub folders on all three media. This action cannot be undone.

When the monophonic WAV file format is selected (in the Record/Play > Track to Media Routing menu), all mono files created for a take follow the name of the take and are stored in a take folder within the selected record folder.



Take Edit Menu

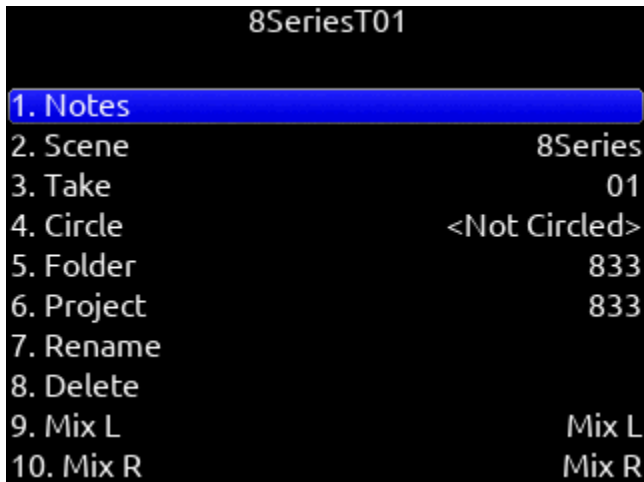

8SeriesT01	
1. Notes	
2. Scene	8Series
3. Take	01
4. Circle	<Not Circled>
5. Folder	833
6. Project	833
7. Rename	
8. Delete	
9. Mix L	Mix L
10. Mix R	Mix R

1. Notes: Edit notes for the selected take. Maximum 200 characters including Sticky Notes.
2. Sticky Notes (next take only): edit sticky notes that are automatically prepended to subsequent takes. Maximum 50 characters.
3. Scene: Edit scene name. Maximum 50 characters.
4. Take: edit Take Number.
5. Circle (current or previous takes only): circle a take. Prepends “@” symbol to take name.
6. Project Edit Project name. Maximum 20 characters. This will become the record folder name if Project is selected as the Folder Type.
7. Delete (current or previous takes only): moves a selected take to a drive's Trash folder.
8. Rename: Renames a take's name. Project, Scene, and Take iXML/bEXT metadata are also updated provided renaming does not change or delete the scene and/or take separator characters.
If a take is renamed and the edit doesn't conform to the current Filename Format setting (with designators), it becomes a freeform take name and metadata will not be updated.
If a take is renamed and the edit conforms to the current Filename Format setting (with designators), the metadata is updated even after renaming a freeform take name.
If a take is renamed and the edit contains a letter following the take designator, the take number metadata is updated only with the numbers immediately following the designator.
9. Track Names: Edit track (channel) names. Maximum 20 characters. A10-TX, A20-Mini, and A20-TX transmitter names can be optionally used to populate the associated isolated track names when used with the A20-Nexus or SL-2. For more information, see 'Use Wireless Names' in the Channel Setup menu (for A20-Nexus) and SuperSlot options menu for SL-2. Channel names for the Next take can also be selected from the Channel Name Manager.

The '+' prefix is added to a filename if an existing take is edited such that it would duplicate the name of another existing take in the same record folder. The 'A' suffix is added if the NEXT take's name is edited such that when recording is started, it would duplicate the name of an existing take in the same record folder.

File List

Menu>Files>File List enters the File List. The File List displays the 833's internal SSD and SD cards and their contents. Various details of each drive, folder, and WAV file are indicated on the right side of the display: TC, FPS, duration, format, tracks, date, time, size.

The File List is also accessible from the Take List by pressing the Tone Switch.



Highlight any WAV file in the File List, then press play to play it back.



File List Options for Files

Copy Folder/File

Provides support for copying Folders and Files between drives from the File List's Options Menu.

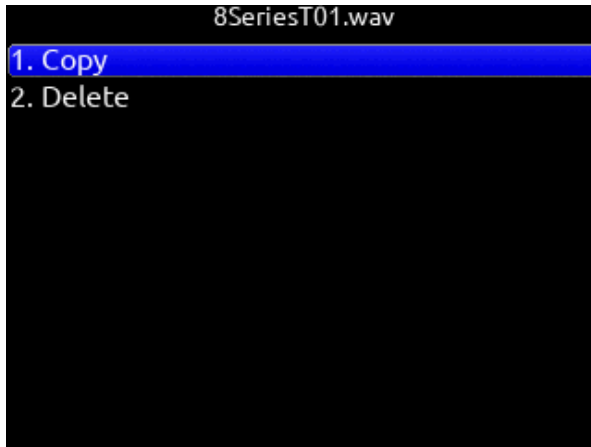

Delete Folder/File

Delete Folders and Files from the File List's Options Menu.

File List Options for Folders

Create Sound Report

Creates a CSV sound report for the selected folder's takes.

The sound report's filename format is MMDDYY_[RecFolderName][Media].csv where Media = '' for SSD, '_1' for SD1, and '_2' for SD2

Rec Folder name = ROLL8, Date = 13th Aug, 2020 would appear as:

081320_ROLL8.csv (on SSD)

081320_ROLL8_1.csv (on SD1)

081320_ROLL8_2.csv (on SD2)

Tip: It is possible to simultaneously create sound reports on all three media for the current Record Folder by setting a Toggle Switch Action, Controller Midi Mapped button, or GPIO to the 'Create Sound Report' function.



Empty Trash

Empties the trash folder.

Empty False Takes

Empties the false takes folder.

Erase/Format

Formats the selected drive. SD1 and SD2 cards can be given a custom volume name during the format process.

Filename Format

Selectable naming conventions for recorded files. Selectable between Scene (Slate) T,+,- Take, or Project ;,% = Scene (Slate) T,+,- Take.

Sound Report Info

Selects the various content for each field of a sound report.

Scene Increment Mode

Defines whether a scene name shall be incremented numerically or alphabetically when the scene increment shortcut is used. When set to 'Character', the last scene character will increment from A through Z, but skipping 'I' and 'O' to avoid being confused with '1' and '0'.

Take Reset Mode

Selects when a Take Number shall reset to 1. Options are: Never, Scene Change, Folder Change, Scene or Folder Change.

Erase/Format Internal SSD

Select to erase/format the internal SSD. Select OK when the "Format Internal SSD?" popup appears.

Erase/Format SD1

Select to erase/format SD1. Enter a custom volume name for the SD card when prompted.

Erase/Format SD2

Select to erase/format SD2. Enter a custom volume name for the SD card when prompted.

USB File Transfer

Enters USB file transfer mode. Files may be transferred between a Mac or PC and 833 via USB-C port. When in USB file transfer mode, playback, record and controller functions are suspended.

Tip: Headphone gain can be adjusted while in File Transfer mode allowing HP volume change while listening to computer USB audio when selected as a source for headphones.

Slate/Coms/Returns

Slate/Com Mic Source

Selects the slate and com mic source. [Off, Int Mic*, Ext Mic, Ext 12 V Mic]

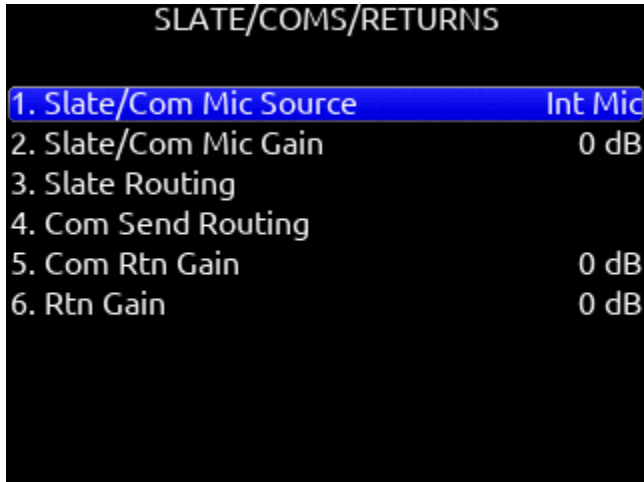

Slate/Com Mic Gain

Selects the gain for the slate/com mic. [-10 to 20 dB in 1 dB steps for the internal mic, 0-60 dB in 1 dB steps for the external mic].

Slate Routing

Selects the destination(s) for the slate mic.

- A. Track: [1-8]
- B. Output: [L,R, X1-X4]
- C. Bus: [L,R, 1-4]
- D. HP- [HP-L, HP-R]
- E. Duck Bus Program (Prgm) By: [0 to -40 dB, -inf]
- F. Duck HP Program (Prgm) By: [0 to -40 dB, -inf]

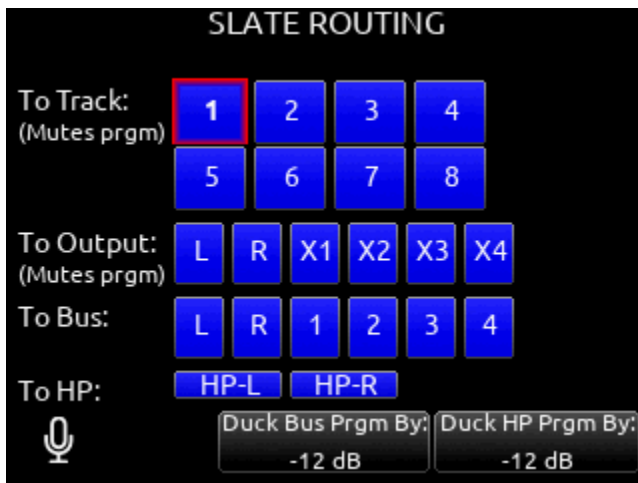

COM Send Routing

Selects the destination(s) for Com Send.

- A. Output: [L,R, X1-X4]
- B. Bus: [L,R, 1-4]
- C. HP: [HP-L, HP-R]
- D. Duck Bus Prgm By: [0 to -40 dB, -inf]

E. Duck HP Prgm By: [0 to -40 dB, -inf]



COM RTN Gain

Selects the gain for Com Rtn in 1 dB increments. [0-30 dB]

RTN Gain

Selects the gain for Rtn in 1 dB increments. [0-30 dB]

Duck Bus Program By

Ducks all audio sent to the bus by a user defined amount.

Duck HP Program By

Ducks all audio sent to headphones by a user defined amount.

When sending coms or slate signal to outputs the program routed to that output is replaced by the com or slate signal.

SuperSlot

When combined with 833, the SL-2 wireless accessory offers integrated control of SuperSlot compatible receivers, monitoring, powering, and RF distribution for multiple channels of wireless audio. Selecting the SuperSlot menu item (or shortcut Meter+HP) navigates directly to the Rx Overview screen.

See SL-2 Receiver Overview for more details.

The SuperSlot menu is grayed out and inaccessible unless a Sound Devices SL-2 Dual SuperSlot Wireless Module is attached to the 833.

The SL-2 Receiver Slot Power or the 8-Series power must be cycled after performing any action that causes a receiver to reboot. Powering receivers on and off from the receiver's user interface is not supported.

SL-2



The SL-2 is a two slot-in wireless receiver integration system that easily mounts to the top panel of any 8-Series mixer-recorder. It accepts UniSlot and SuperSlot™ wireless receivers from a variety of manufacturers. Power to the SL-2 and receivers is supplied by the 8-Series mixer-recorder – no external DC connector is needed on the SL-2. Analog or digital audio is sent from the receivers into the mixer-recorder via the expansion port, reducing messy cabling for power and audio connectivity.

The SL-2 offers antenna distribution to slot-in receivers, spreading out the placement of antennas for better RF performance. Additionally the SL-2 allows for control of smart antennas and includes two filtered antenna outputs to external receivers via MCX ports. The rear panel of the SL-2 is equipped with two TA3 connectors for an additional four inputs of AES3 audio and two 4-pin Hirose DC Outputs, each supplying up to 500 mA.

Up to eight channels of audio can be routed from the SL-2 to the 833. The eight channels can be comprised of audio from dual or quad channel slot in receivers and/or the four AES inputs.

The SL-2 mounts to the 833 via the multi-pin expansion port located on the top panel. Please refer to the SL-2 User Guide for panel descriptions and installation instructions.

WARNING! To avoid potential hardware damage, turn off power to the SL-2 slot prior to removing and inserting receivers. Slot power can be turned off in Menu>System>Expansion Port, Menu>SuperSlot>Options>Slot Power, or by powering off the 8-Series Mixer-Recorder.

Supported SuperSlot receivers for use in the SL-2 are:

- Sound Devices A20-RX
- Audio Ltd. A10-RX
- Lectrosonics SRb, SRc, SRc-941, SRb5P (Slot A only), SRc5P (Slot A only)
- Lectrosonics DSR4 (4ch digital audio per slot)
- Lectrosonics DSR
- Sennheiser EK6042 (does not support scan)
- Shure ADX5D
- Sony DWR-S03D
- Wisycom MCR42
- Wisycom MCR54 (4ch digital audio per slot)

Powering the SL-2

The SL-2 is powered by the 833 via the Expansion Port. No additional power source is needed to power the SL-2.

To activate the SL-2, set the System>Expansion Port menu to On.

Save power when the SL-2 is not in use by setting the Expansion Port menu to Off. When the Expansion Port is set to Off, the SuperSlot menu is grayed out.

Routing SL-2 Sources to Channels

The SL-2 has 12 selectable sources and can send up to 8 channels of audio to the mixer/recorder. 8 channels are available if all sources are AES digital. If a slot receiver output is analog, 6 channels are available and AES 3 and 4 cannot be selected.

To route an SL-2 Source to a channel, access a channel's source screen and select from A1-A4, B1-B4, AES 1-4. When A1-A4, B1-B4 are selected as source, use the */** toggle as a shortcut to the selected receiver's setup screen.

For SL-2 A1-A4, B1-B4, and AES 1-4 sources, channel trim gain range is -20 to 50 dB.

When an A10-RX/A20-RX is receiving signal from an A20-Mini or A20-TX, the trim gain of the associated 8-Series channel is 0 to 60 dB. See GainForward.

RF Overload LEDs

Each antenna input on the front panel of the SL-2 has an associated LED that displays incoming RF level status.

Red = approaching RF overload threshold of the SL-2

Orange = approaching overload threshold of digital wireless systems

Off = no overload

To disable the LEDs go to SL-2 Options>Antenna LEDs and set to Off.

SL-2 Receiver Overview

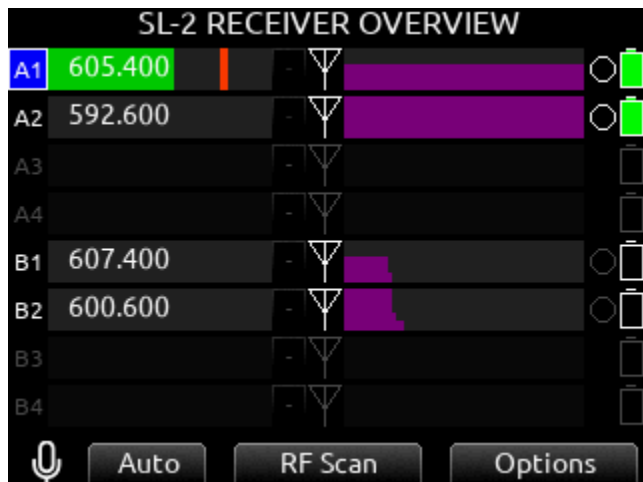

Select the SuperSlot menu to enter the SL-2 Receiver Overview screen which displays information for all receivers connected to the SL-2. Hold Meter then press the HP knob to quickly access the Receiver Overview screen.

A1-A4, B1-B4

Use the Select knob to scroll and select an SL-2 channel to access the individual Receiver Setup screen. See Receiver Setup Screen for more details.

Post-trim Channel Metering

Displays the post-trim audio level of the 888 channel receiving audio from the SL-2 source. When the SL-2 source is not routed to a 888 channel, no signal is displayed on the meters.

RF Frequency

Displays the frequency of the receiver in MHz.

Transmitter Battery Level

Displays the battery level of the paired transmitter, if applicable.

Green = over 50%

Yellow = over 20%

Orange = over 10%

Red = less than 10%.

Transmitter Record Status

Indicates the record status of the paired transmitter, if applicable. Red = recording

Transmitter Status Box (A20-RX/A10-RX only)

A10-TX: Indicates paired transmitter Mute, Limiter, and Audio Overload status.

A20-Mini, A20-TX: Indicates paired transmitter Mute status. The Limiter and Audio Overload indicator are displayed for the 8-Series channel receiving the A20-Mini or A20-TX signal.

Blue with 'M' = Transmitter Mute On

Yellow with 'L' = Limiting

Red with 'O' = Audio Overload

RF Level History

Displays the RF level over a period of time. Duration of RF History is set in SL-2 Options>RF History Duration parameter from 30 to 600 seconds in 10 s steps, default duration is 30 seconds. The taller the green bar, the healthier the received RF signal. A yellow bar signifies receiver is approaching RF overload (A20-RX only). A red bar signifies receiver RF overload (A10-RX and A20-RX only).

RX Antenna Icon

Indicates RF signal status.

Solid white = locked to antenna signal

Flashing white = antenna signal unlocked

Solid Red = antenna signal overload

Gray = no receiver detected

Auto (A20-RX only)

Starts scanning for clean frequencies to auto-assign to receiver channels. Use the Tone toggle to start the process. When the AutoAssign scan is complete, the AutoAssign screen is displayed. Use the Select knob to select which receiver channels to assign the clean frequencies to. A selected channel displays the clean frequency that will be assigned. Press the HP knob to assign the clean frequencies to the selected channels.

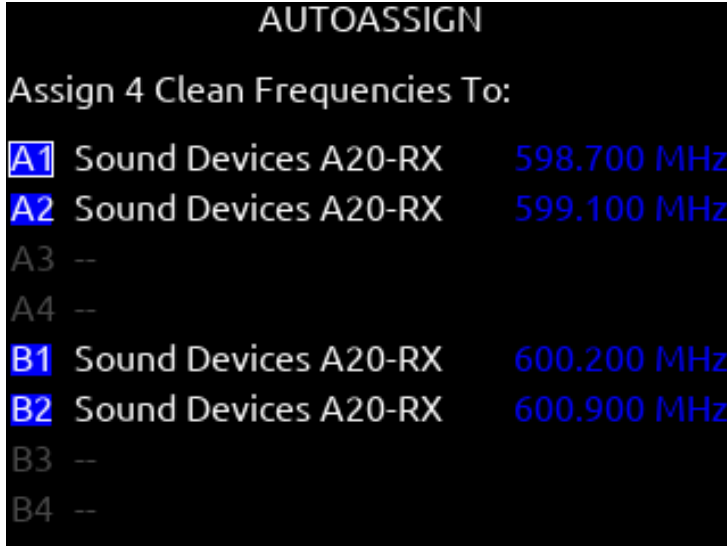

RF Scan

Instigates an RF Scan of the environment using one or both receivers depending on the receiver model. Use the **/* toggle switch to start the scan.

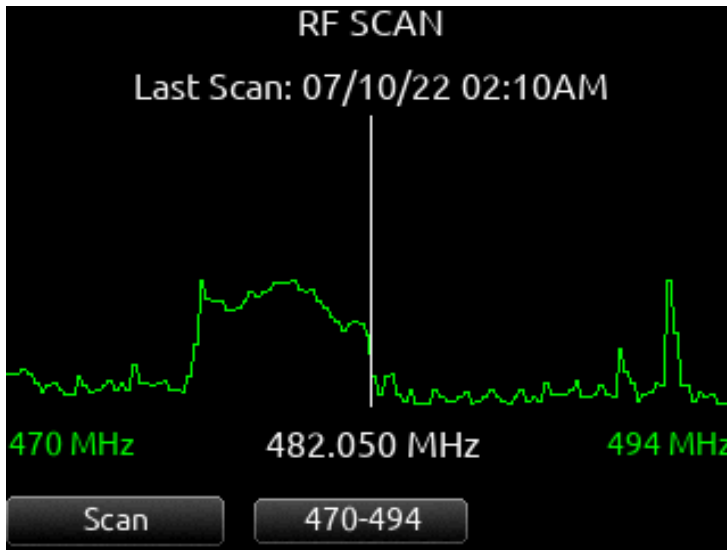

Options

Access the SL-2 Options menu by using the Rtn/Fav toggle switch.

SL-2 Options

Provides access to various SL-2 settings.

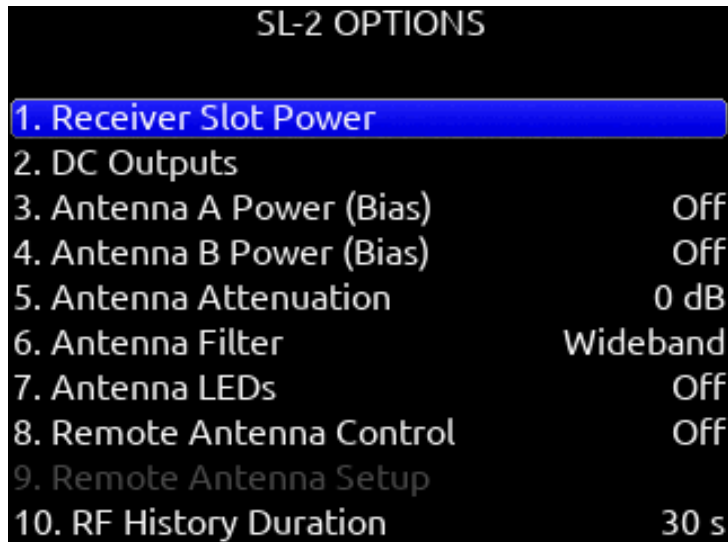

Receiver Slot Power

Each slot can be individually turned On/Off to save power when not in use. Powering receivers on and off from the receiver's user interface is not supported.

DC Outputs

Enable/disable DC Outputs 1 and/or 2.

Antenna A/B Power (bias)

Provides 12 V DC bias power for active or smart antennas.

Antenna Attenuation

Apply attenuation to reduce the possibility of RF overload. Select from 0 to -18 dB in 6 dB steps.

Antenna Filter

Select the SL-2's front end filter to reduce the likelihood of out-of-band RF noise affecting range. Select from Wideband, 169-235 MHz, 470-614 MHz, 542-694 MHz, 606-770 MHz, 770-960 MHz, 1240-1525 MHz.

Antenna LEDs

Antenna LEDs can be toggled On*/Off.

Remote Antenna Control

Enables/disables Remote (Smart) Antenna Control.

Remote Antenna Setup

See "Remote Antenna Setup" details below.

RF History Duration

Sets the duration of the RF HISTORY plot. Select from 30 to 600 seconds in 10 second steps, default duration is 30 seconds.

Use Wireless Names

The name associated with the receiver channel is automatically applied to the isolated track receiving the signal. This feature is supported by the Audio Ltd. A10-RX, A20-RX, Shure ADX5D, and the Wisycom MCR54.

Unislot Audio Mode

Enables the manual selection of analog or digital audio output from a Unislot slot receiver. This allows for receivers that support digital audio but that are not supported in 'SuperSlot' mode.

Remote Antenna Setup

Configures the various settings for connected remote (smart) antennas. The menu is grayed out if Remote Antenna Control is Off and/or no remote antenna is detected. A remote antenna requires bias power. The SL-2 supports the Wisycom LFA smart antenna and BFA smart filter.



Antenna A/B Gain

Sets gain of Antenna A or B in 1 dB steps. [Off, Bypass, -12 to 27dB]

Antenna A/B Filter Type

Sets the filter type of Antenna A or B. [Tunable, NB, or WB] (Selected in Freq field: 410-810, 410-700, 410-600, 470-810, 470-700, 470-600, 510-810, 510-700, 510-600); NB (940-960MHz, freq is fixed at 940-960 and cannot be changed)]

Antenna Frequency

Sets the filter freq of Antenna A or B. Frequencies available depend on the Wisycom LFA/BFA model, F1, F2, F3, or F6. Please refer to the Wisycom documentation for filter frequency detailed information. [When Filter is set to NB, Frequency is fixed at 940-960 and cannot be changed. When Filter is set to WB, Freq can be set to 410-810, 410-700, 410-600, 470-810, 470-700, 470-600, 510-810, 510-700, 510-600. When Filter is set to Tunable, Filter Frequency can be adjusted in 40 MHz blocks from 410-450 to 690-730 in 1 MHz steps.]

Antenna A/B Settings

Provides access to additional Antenna A or B settings.

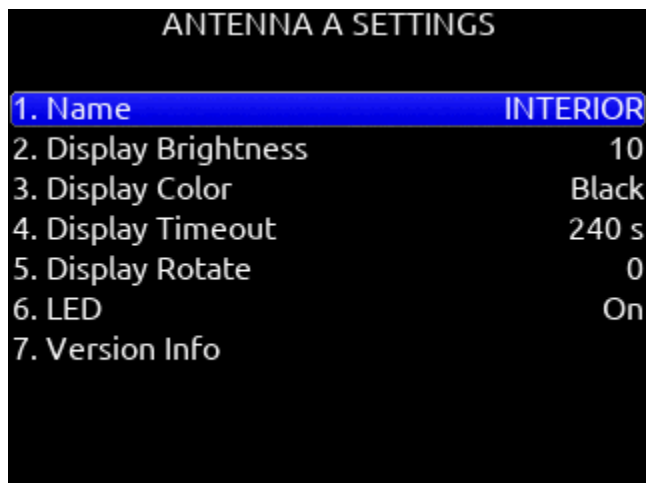

Name

Displays name of Antenna A/B.

Display Brightness

Sets Antenna A/B display brightness in increments of 1. [1-10]

Display Color

Sets Antenna A/B display color. [White, Black]

Display Timeout

Sets the duration of Antenna A/B display timeout in steps of 1 second. [5 to 240 seconds]

Display Rotate

Sets the rotation of the Antenna A/B display. [0 or 180]

LED

Sets Antenna A/B LED activity. [On or Off]

Version Info

Displays system information about the Wisycom LFA-B-F1.

Receiver Setup Screens

When the SL-2 is attached, you can access Receiver Setup screens for any of the supported SuperSlot receivers available. Receiver Setup screens provide access to individual receiver RF scanning, menus for receiver setup, RF frequency adjustment, RF and audio level monitoring, transmitter recording status, transmitter Limiter/Overload/Mute status (A20-RX/A10-RX only), and more. The transmitter status and menu settings available depend on the receiver. Access the Receiver Setup screen from within the Receiver Overview screen by selecting the receiver channel (A1-A4, B1-B4) using the Select knob.

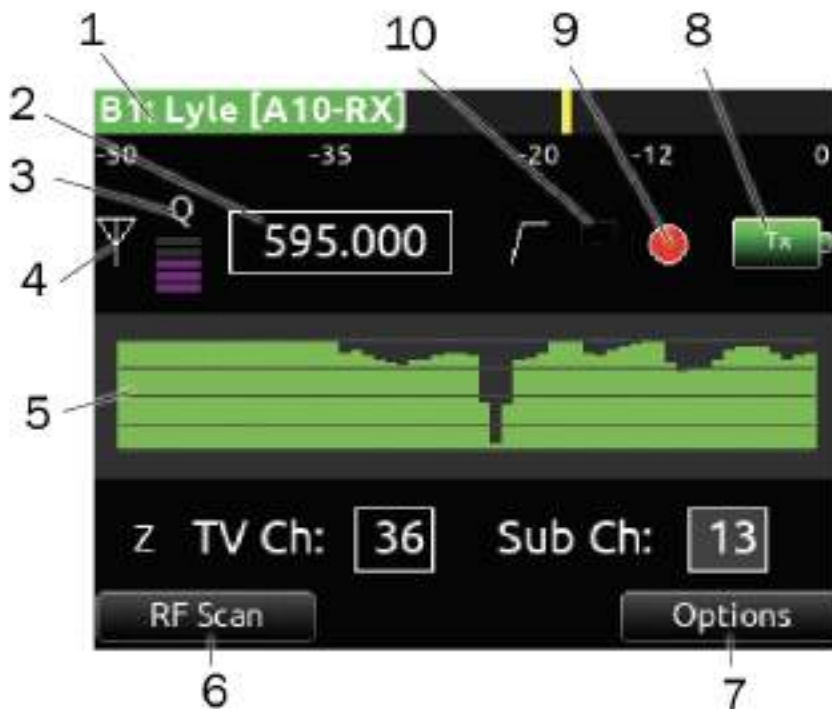

1: Post-trim Channel Metering

Displays the post-trim audio level of the 833 channel receiving audio from the SL-2 source. When the SL-2 source is not routed to an 833 channel, no signal is displayed on the meters.

2: RF Frequency

Set Receiver channel frequency in MHz or by TV channel and Sub channel.

3: Q-meter

The A20-RX/A10-RX Q-meter displays the difference between the signal from the transmitter and any interference using five bars. When a frequency without little to no interference is selected, the Q-meter will display five bars. Some third party receiver's have their own version of this meter.

4: RX Antenna Icon

Indicates RF signal status.

Solid white = locked to antenna signal

Flashing white = antenna signal unlocked

Solid Red = antenna signal overload

Gray = no receiver detected

(Not applicable to the Lectrosonics SRb/SRc which uses 'P' to indicate pilot tone lock status.)

5: RF Level History

Displays the RF level over a period of time. Duration of RF History is set in SuperSlot>SL-2/SL-6 Options>RF History Duration parameter from 30 to 600 seconds in 10 s steps, default duration is 30 s. The taller the bar, the healthier the received RF signal.

The RF History Levels setting determines the source of the data drawn. RSSI is displayed in green and Quality in purple. The RF History Levels option is available on Audio Ltd A10-RX, Sound Devices A20-RX, Shure ADX5D, and Wisycom MCR54. A yellow bar signifies receiver is approaching RF overload (A20-RX only). A red bar signifies receiver RF overload (A10-RX, A20-RX, and Shure ADX5D only). An orange bar signifies RF interference (Shure ADX5D only).

6: RF Scan

Instigates an RF Scan of the environment using an individual SuperSlot receiver. Use the Mic/Tone toggle switch to start the scan. A red line signifies the squelch level of the Wisycom MCR54 and MCR42. Squelch level is only displayed in individual RX Scan screens and not in the RF Overview Scan screen.

7: Options

Provides access to additional settings of the selected receiver. Options vary depending on the manufacturer and model of the receiver selected. Please refer to the user guide provided by the manufacturer of the receiver for more details.

8: TX Battery Level

Displays the battery level of the paired TX, if applicable.

Green = over 50%

Yellow = over 20%

Orange = over 10%

Red = less than 10%.

9: TX Record Status

Indicates the record status of the paired transmitter, if supported.

Red = recording

10: TX Status Box (A20-RX/A10-RX only)

A10-TX: Indicates paired transmitter mute, Limiter, and Audio Overload status.

A20-Mini: Indicates paired transmitter mute status. The limiter and audio load indicator are displayed for the 8-Series channel receiving the A20-Mini signal.

Blue with 'M' = TX Mute On

Yellow with 'L' = Limiting

Red with 'O' = Audio Overload

A20-RX/A10-RX

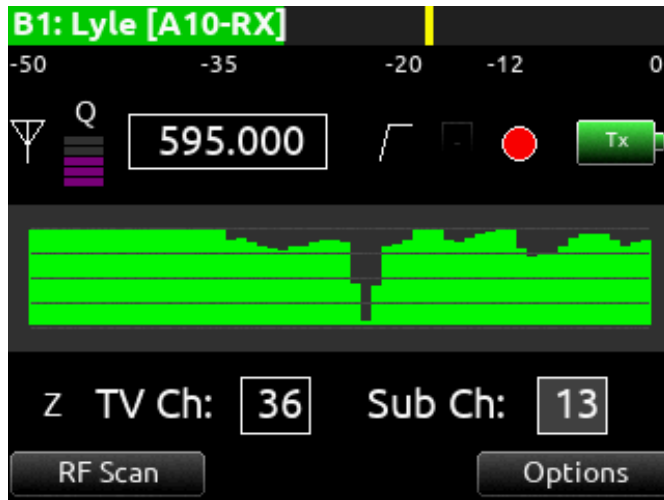

GainForward (A20 Transmitters)

The A20 transmitters introduce GainForward, a new feature that eliminates the need to adjust microphone preamplifier gain at the wireless transmitter. Audio levels from the transmitter are controlled directly at the mixer's trim control. If the talent speaks too softly or emotes too loudly after being "wired" with the transmitter, simply adjust the transmitter gain with the mixer's gain trim. Read more about GainForward at:

<https://www.sounddevices.com/gainforward-explained/>

Adjusting Audio of the A20 Transmitter Signal from 833

When the A20-RX/A10-RX receiving A20 transmitter signal is slotted into the SL-2, the A20-RX/A10-RX Input menu settings are bypassed and all gain, low cut, and limiter activity are performed and controlled by 833. See the A20-Mini/A20-TX and A10-RX/A20-RX User Guides for more information.

When 888 is receiving A20 transmitter signals via SuperSlot the 833s' trim gain is adjustable from 0 to 60 dB. The A10-RX or A20-TX Receiver screens display the associated 833 channel's low cut, audio overload, and limiter activity.

A10-TX does not support GainForward.

Use Wireless Names For Track names

A10-TX and A20 transmitter names can be set to automatically be applied as the 833's isolated track name for the channel receiving the signal. Set Use Wireless Names to On in the SL-2 Options menu.

Third-Party Supported SuperSlot Receivers

The following pages show the Receiver Setup screens and the options menus for third-party supported SuperSlot receivers. Refer to the manufacturer for full details on features and functionality of these receivers.

Lectrosonics SRB

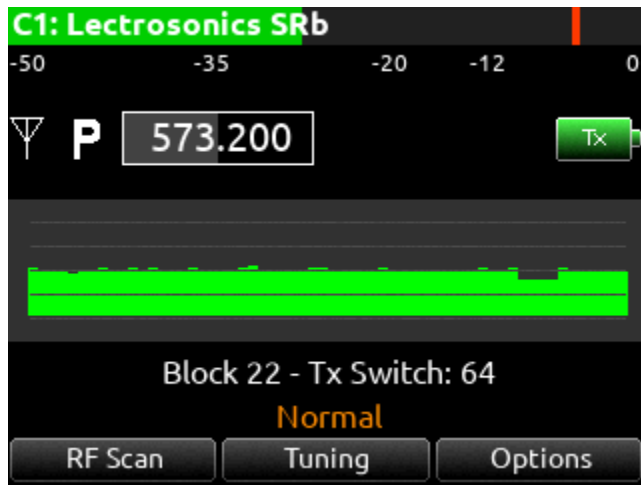

-
- The screenshot shows the options menu for Lectrosonics SRB. The menu items are:
- 1. Compatibility Hybrid
 - 2. Diversity Mode Switch
 - 3. Smart Noise Reduction Normal
 - 4. Pilot Tone Bypass Off
 - 5. Tx Battery Type AA (Timer)
 - 6. Calibration Tone Off
 - 7. Show Receiver Info

Lectrosonics SRC

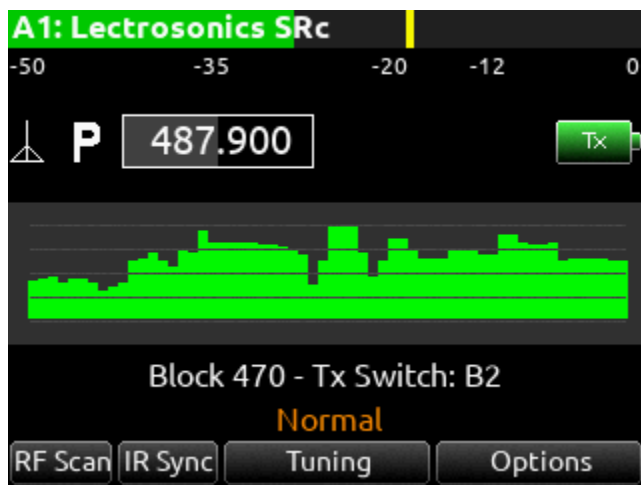

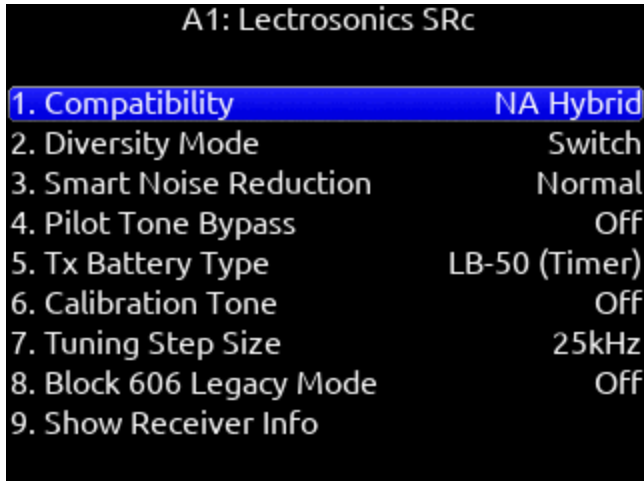

Lectrosonics DSR4

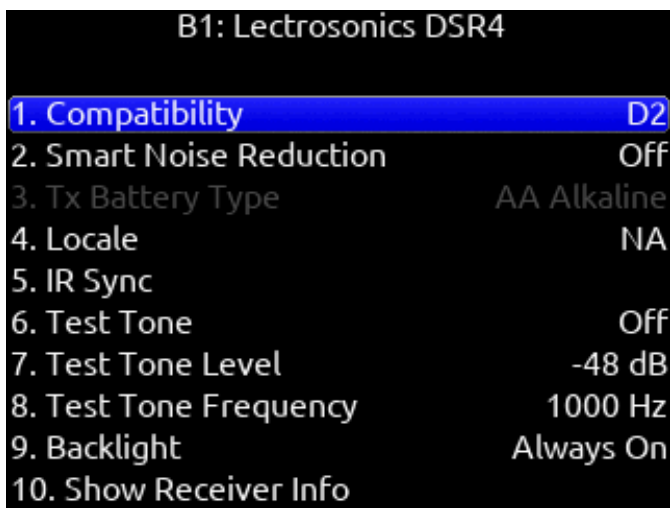

Sennheiser EK6042

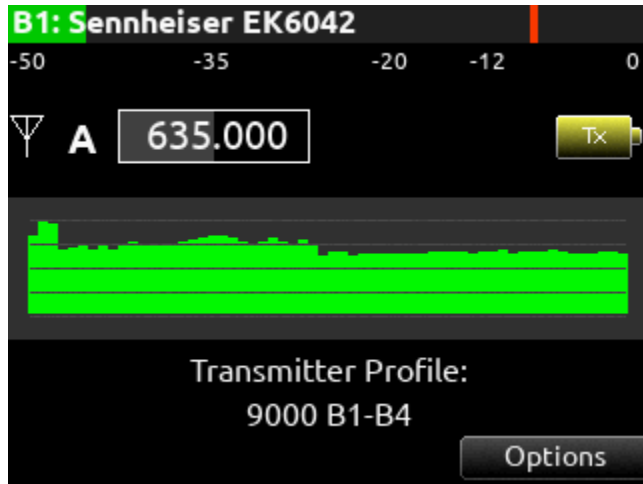

- B2: Sennheiser EK6042**
- 1. Calibration Tone Off
 - 2. Squelch Level 19 dB μ V
 - 3. Pilot Squelch Active
 - 4. Show Receiver Info

Shure ADX5D

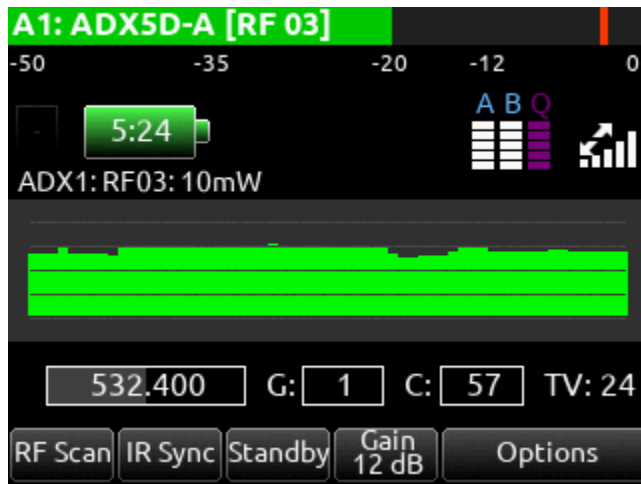

The screenshot shows the settings menu for 'B1: Shure ADX5D'. The menu items are as follows:

Item	Value
1. Device ID	ADX5D-A
2. Channel Name	RF 03
3. RF Band	G57+
4. ShowLink	Direct
5. Tone Generator Level	Off
6. Tone Generator Frequency	400 Hz
7. RF History Levels	RSSI
8. Show Receiver Info	

The SL-2 or SL-6 Receiver Slot Power or the 8-Series power must be cycled after performing any action from the Shure ADX5D user interface requiring the receiver to reboot. This includes powering the Shure ADX5D on and off, changing Transmission Mode, changing 3rd Party Control, or performing a Factory Reset.

SuperSlot Control of the Shure ADX5D is only available when Device Cfg >> Advanced >> 3rd Party Control is On.

When the Shure ADX5D is in High Density Transmission mode, Groups and Channels must be set from the ADX5D interface.

Sony DWR-S03D

A2: Sony DWR-S03D [DWT B30-0000001]

-50 -35 -20 -12 0

Antenna icon **B** 542.125 QL 10mW Tx

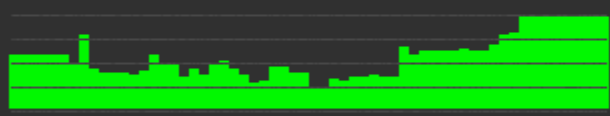

GR: 00 TV30-32 CH: 3001

RF Clear Scan Tx Options Rx Options

A1: Sony DWR-S03D - Rx Options

- 1. Band Block TV21-29
- 2. Dimmer Mode Auto Dim
- 3. Brightness 7
- 4. Codec Mode Mode 2
- 5. Transmitter Search
- 6. Show Receiver Info

Wisycom MCR42

B1: Wisycom MCR42

-50 -35 -20 -12 0

Antenna icon **A** 626.000 Tx



GR: 00 UNLOCK CH: 17

RF Group Scan Options

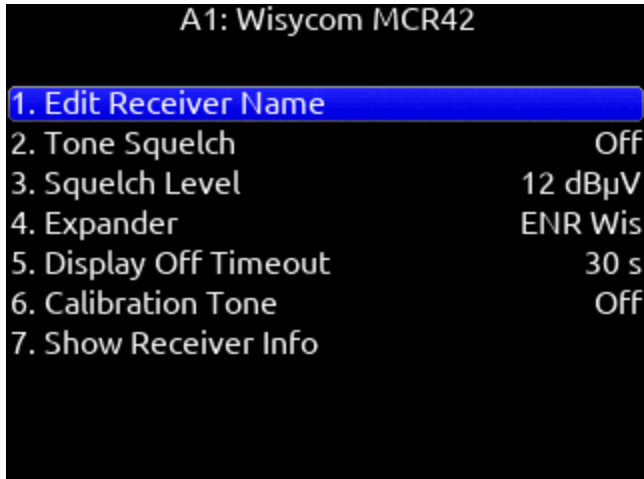

Wisycom MCR54

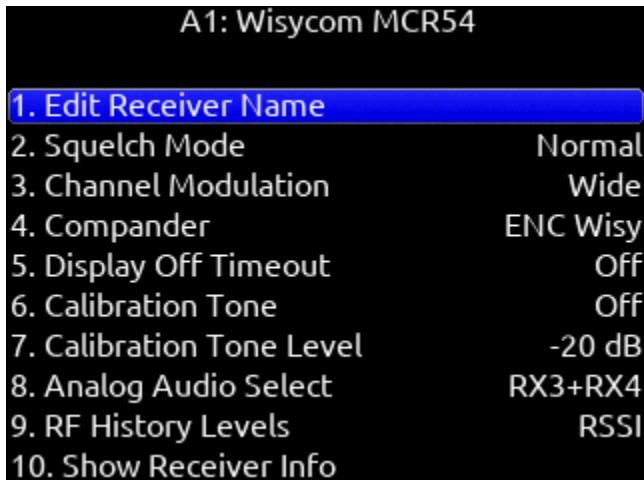

A20-Nexus/A20-Nexus Go

The A20-Nexus and A20-Nexus Go are ultra-high performance, multichannel wireless receivers in a compact ½-rack wide chassis that can be docked to Sound Devices 833, 888, or Scorpio mixer-recorder using the A20-QuickDock accessory, which provides convenient power, audio, and timecode connections with no cables. This accessory allows the A20-Nexus and A20-Nexus Go to connect and disconnect from the 833, 888, or Scorpio in seconds with no tools.

See the online A20-Nexus, A20-Nexus Go User Guides for more detailed information.

System

Tone Setup

Selects the level, frequency, and routing of the internal tone generator.

1. Level- Selects the level of the tone generator from -20 - 0 dBFS in 1 dB increments. [-20 - 0 dBFS]
2. Frequency- Selects the frequency of the tone from 100 to 10 kHz in 10 Hz steps. [100-10 kHz]
3. Track- [1-8]
4. Output- [L,R, X1-X4]
5. Bus- [L,R, 1-4]

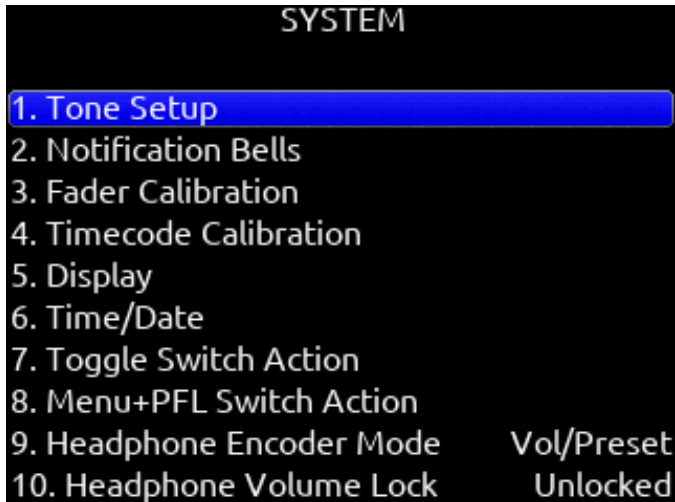

Notification Bells

Selects settings for the notification bells.

1. To HP- Routes notification bell tones to the headphones. [HP-L, HP-R]
2. To Bus- Routes notification bell tones to the buses. [L,R, 1-4]
3. When...- Selects when the notification bell tones are used. [Rec/Stop, Space Low, Power Low, Warning Popups].
4. Level- Selects the level at which the notification bell tones will be played in 1 dB increments. [Muted, -60 to -12dBFS]



Fader Calibration

Selects the option to manually calibrate all faders.

Timecode Calibration

Select Timecode Calibration to tune the system clock to an external LTC signal. This can be used to ensure zero TC drift between the 833 and external timecode devices. Select Reset to Factory Calibration to return to the factory calibration setting.

Note: Calibration values are stored in the 833's saved settings files. When loading a settings file created using another 833, it is highly recommended to perform a 'Reset to Factory Calibration' or 'Timecode Calibration' after loading the settings, otherwise the calibration settings from the other machine will be used which could result in noticeable timecode drift.

Display

Provides various options for configuring the LCD display.

1. Daylight Mode: Turn On to change background color from black to white to assist viewing in bright sunlight. All UI element colors are changed to optimize visibility. Changing the Daylight Mode returns to the Meter View. Tip: Press Select and HP at the same time to toggle Daylight Mode.
2. LED Brightness - Selects the front panel LED brightness in 1% steps. [1%-100%]
3. LCD Brightness - Selects the LCD in 10% steps. [10%-100%]

Time/Date

Selects the current date and time.

1. Time Format [12*, 24 hr].
2. Date Format [mm/dd/yy*, dd/mm/yy, yy/mm/dd].
3. Set Time/Date Selects the current date and time.
4. Time Zone [-12 to +13 hours GMT].
5. Daylight Saving [On, Off*].

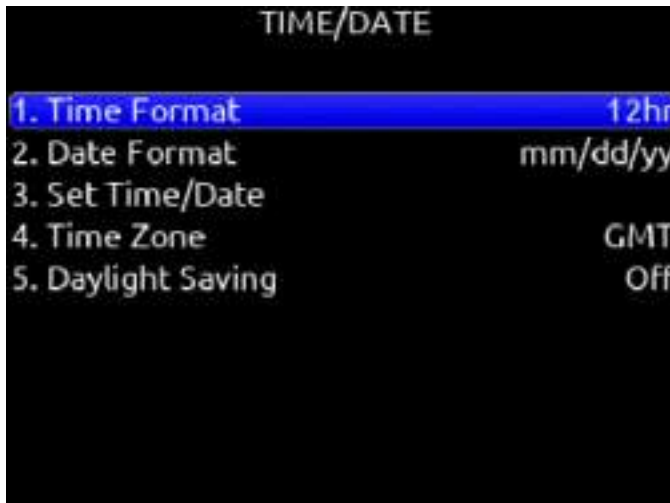

Toggle Switch Action

Chooses what function is assigned to the toggle switches.

Menu + PFL Switch Action

Chooses what menu is assigned to a Menu + PFL Switch action.

Headphone Encoder Mode

Selects default operation of the HP encoder [Vol/Preset*, Preset/Vol]

Headphone Volume Lock

Set to locked to prevent the headphone volume from being accidentally changed.

Bluetooth

Enables or disables Bluetooth LE [On, Off]. Set to On to connect to iPad or Android SD-Remote application. Setup a password to protect against unauthorized remote control.

Expansion Port

Enables powering of accessories via the top panel multi-pin port [On, Off]. Accessories include the A20-Nexus, the XL-AES and SL-2.

Version Info

Indicates current firmware version. The version number is also displayed on the splash screen during bootup.

Regulatory

Displays relevant compliance information.

Plugins

Shows plugins installed on the 8-Series mixer-recorder. Activates plugins on the SSD or SD card stored as LIC files. Plugins can be purchased at store.sounddevices.com

Plugins

Plugins can be purchased and downloaded from store.sounddevices.com.

The following plugins are available for the 833:

833 +4

Adds four fully featured ISO channels/record tracks, turning your 833 into a 12 channel, 16 track mixer-recorder.

NoiseAssist

Suppress background noise instantly on-location with the optional NoiseAssist plugin for 8-Series mixer-recorders. Choose between 2, 4, and 8 instances that can be applied to any channel or bus!

CEDAR sdnx

CEDAR sdnx brings CEDAR Audio Ltd.'s highly-regarded noise suppression technology to 8-Series mixer-recorders. Choose between 2, 4, and 8 instances that can be applied to any channel or bus!

To Install a Plugin

Ensure the firmware version is compatible with the plugin.

1. Download the plugin file from the plugin store.
2. Unzip the folder and locate the license (LIC) file.
3. Place the LIC file on the root of an SD card formatted by the 8-Series or place on the SSD while in file transfer mode.
4. Insert the SD card into the 8-Series.
5. Navigate to Menu>System>Plugins.
6. Enter the Plugins menu and select "Apply Plugins". The plugin will install and the 8-Series mixer-recorder will restart.

Show Plugins

Allows you to see which Plugins have been installed on the device.

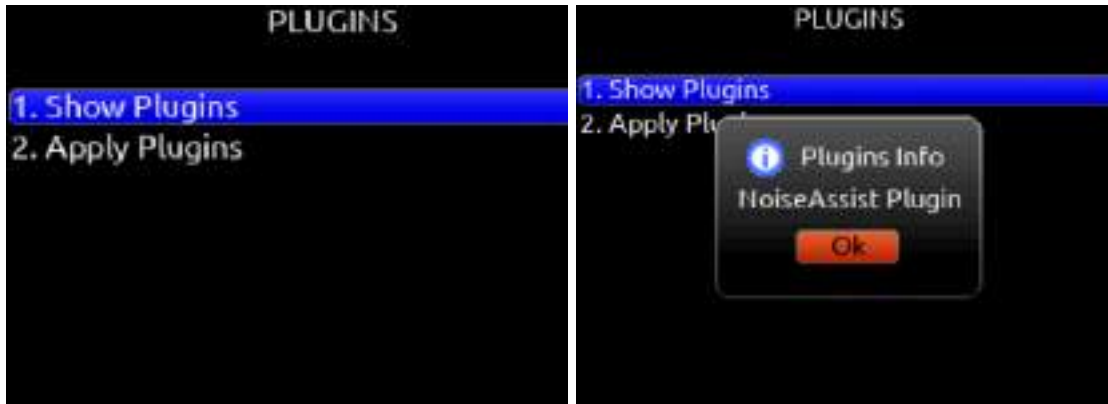

The 833 +4 Plugin

The 833 +4 Plugin adds four fully featured ISO channels/record tracks, turning your 833 into a 12 channel, 16 track mixer-recorder.

Channels 9-12 setup screens are accessed via Menu>Channels 7-12. All features of Channels 1-8 are available on Channels 9-12.

When the +4 Plugin is installed, various menus, UI elements, and functions are updated to support channels 9-12.

- Meter View option LR, 1-12
- Routing menus for Channel Grouping, Buses, Outputs, Automixer, and Noise Suppression (if NoiseAssist or CEDAR sdx Plugin is installed)
- SD-Remote offers full support of metering and control of channels 9-12
- External Controllers offer full support of channels 9-12
- Ch 9-12 Trim/PFL (Latch) options added to Toggle Switch Actions: Mic, Select + Mic, HP + Mic, *, **, Rtn, Select + Rtn, HP + Rtn, Fav, Select + Fav, HP + Fav



Noise Suppression Plugins

Suppress background noise instantly on-location with the optional CEDAR sdnx or Sound Devices NoiseAssist plugins for 8-Series mixer-recorders.

CEDAR sdnx

Over the last few decades, CEDAR has become synonymous with real-time, low-latency, and artifact-free audio restoration and noise suppression. CEDAR Audio Ltd.'s sdnx brings CEDAR's highly-regarded noise suppression technology to 8-Series mixer-recorders. This optional plugin reduces unwanted background noises so you can better capture dialog.

CEDAR sdnx has near-zero latency and one simple control for adjusting the amount of suppression. Up to 8 instances of CEDAR sdnx are available per mixer-recorder/device. These instances can run on any combination of isolated channels or bus. The plugin functions at sample rates up to and including 96 kHz.

Previously, using CEDAR with an 8-Series mixer-recorder required a separate hardware unit like the CEDAR DNS 2. This collaboration between CEDAR and Sound Devices marks the first time CEDAR technology has been available in-unit for any portable mixer-recorder. Now, even ultra-light portable recording setups have access to CEDAR noise suppression.

CEDAR sdnx requires 8-Series firmware v7.40 or higher. Want to try before you buy? The 2-instance version of the plugin is available as a demo on 8-Series running v7.40 or higher.



Sound Devices NoiseAssist

NoiseAssist is an advanced signal processing algorithm that reduces background noises such as traffic, generators, HVAC noise, and more. The plugins continuously monitor background noise to give you clean audio for the entire take.

Using NoiseAssist is easy and fast - simply adjust the amount of background noise to suppress and NoiseAssist will do the rest. Suppression happens in real time with just 1 ms of latency - no "learning" required. Depending on the plugin purchased, two-, four-, or eight- instances of NoiseAssist can run on any combination of isolated channels and/or any bus.

This algorithm is optimized specifically for high-end professional film and television dialog. It accurately distinguishes the desired speech signal from background noise using proprietary advanced multi-band frequency, level, and statistical calculations. NoiseAssist maintains the excellent frequency bandwidth of the audio channel, while effectively suppressing the background noise and reverberation.

NoiseAssist Plugins are available for purchase at store.sounddevices.com

Try the two-instance version of NoiseAssist Plugin in demo mode (tone bursts replace audio every 10 seconds) until the NoiseAssist Plugin license is purchased and installed. The NoiseAssist demo mode is disabled when the 8-Series is powered down.



Mode

Selects NoiseAssist or CEDAR sdnx and whether Noise Suppression is disabled* or enabled.

The Noise Suppression field in the channel and bus screens shows as NA when NoiseAssist is active and NX when CEDAR sdnx is active.

Note: Set a toggle shortcut or mapped controller button to enable/ disable Noise Suppression to allow you to quickly compare the effect of it being on or off.

Channel/Bus Selection

Selects up to eight (depending on plugin installed) instances of Noise Suppression and which channels and/or Buses it is applied to. If the maximum number of instances are already selected, deselect one instance before selecting another.

Note: Noise Suppression only affects the mix of ISOs and return bus sources when applied to buses receiving audio from L, R, B1, B2 buses.

Note: NoiseAssist and CEDAR sdnx cannot be used at the same time. NoiseAssist is only available at sample rates of 48.048 kHz and less. CEDAR sdnx is only available at sample rates of 96 kHz and less.

Adjusting Noise Suppression

In the Noise Suppression menu, ensure Noise Suppression is enabled and the required channel and/or bus is selected.

For a Channel: Enter the channel screen using the PFL toggle. Use the Select knob to scroll to and enter the NoiseAssist (NA) or CEDAR sdnx (NX) field. Rotate the Select knob to set the amount of Noise Suppression applied to the channel.

For a Bus L,R: Go to Menu>Buses and select Bus L or Bus R, whichever has been enabled for Noise Suppression. Push the */** toggle to the right to select the NA or NX parameter and rotate the Select knob to set the amount of Noise Suppression applied to the bus.

For a Bus B1-B4: Go to Menu>Buses and select Bus 1-4, whichever has been enabled for Noise Suppression. Push Tone toggle to display more options then push the */** toggle to the right to select the NA or NX parameter and rotate the Select knob to set the amount of Noise Suppression applied to the bus.

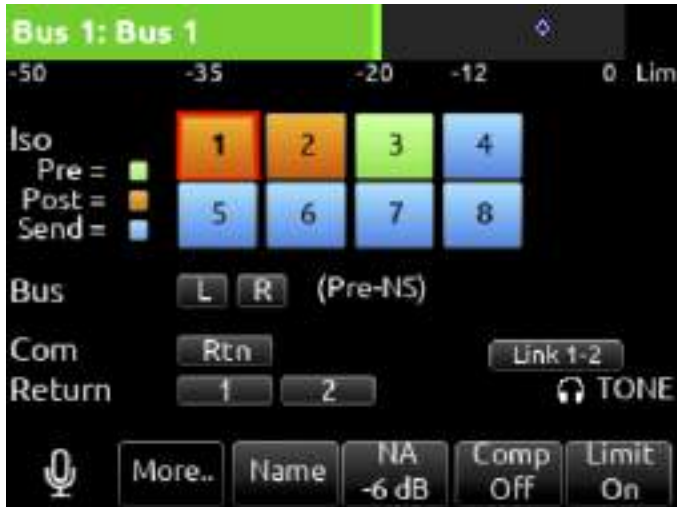

Noise Suppression values range from 0 dB to -20 dB with 0 dB representing no noise attenuation and -20 dB being the maximum amount of noise attenuation.

Channels or Buses enabled for Noise Suppression show a diamond in their meters. The diamond moves based on the amount of Noise Suppression averaged across all the frequency bands that have signal in them.

The lower the diamond on the meter scale, the more the background noise is being attenuated. The diamond moves towards the top of the scale as the audio signal changes (for example, when a mic picks up dialog) - this indicates that the Noise Suppression algorithm is learning and adapting to the signal in real-time.

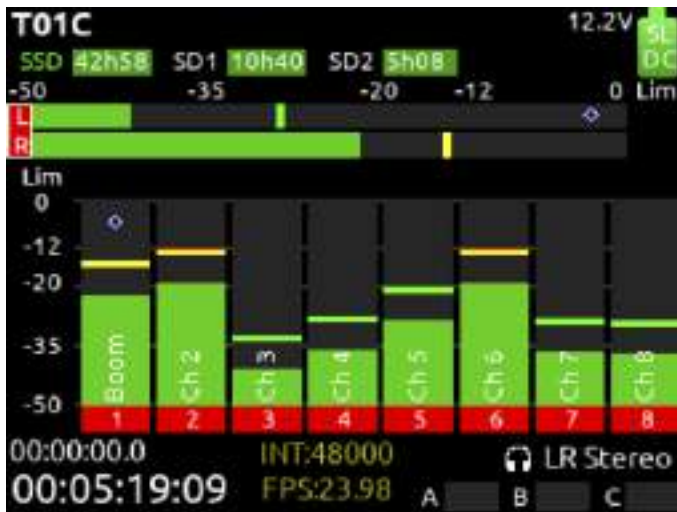

To effectively use Noise Suppression, start with the default setting of -6 dB and dial in more or less depending on your environment. An ideal setting will reduce the background noise without coloring the sound.

Note: NoiseAssist and CEDAR sdnx are not automatically linked when channels or buses are linked.

Controllers

833 can be controlled from the Sound Devices CL-16 or CL-12 linear fader controllers or supported third-party external controllers that conform to the MCU protocol.

Controllers connect via the 833's USB-A port either directly or via a USB hub.



Mapping

Selects Mapping menu. Mapping provides the ability to learn controller button presses and map them to a desired function. The action of pressing two buttons simultaneously can also be mapped.

Note: some buttons or button combinations are reserved and cannot be mapped.

- A. Name: Allows for custom naming of controller button.
- B. MIDI: Toggles between the button name and MIDI code of the selected button function.
- C. Load: Loads a saved button mapping preset.
- D. Save: Saves a button mapping preset to any/all media. Toggle "Fav" after media selection to save.
- E. Learn: Selects learn function. To use, toggle Learn and press the desired button to be learned on the controller. Once the button has been learned, press the HP knob to scroll through the possible list of available functions (shown below) that can be assigned and select the desired function.
- F. Reset: Deletes the currently selected button mapping in the Mapping menu.



Mappable Functions

All controllers have custom-mappable buttons for performing any of the following actions on 833:

Function	Action
Add Q-mark	Adds a Q-mark during record, playback, scrub or pause
Auto Mixer On/Off	Toggles the Auto Mixer on/off
Bus Mode	Bus Masters
Channel Groups Edit	Create/Edit channel groups
Channel Sends on Faders	Shortcut to put Bus sends on linear faders/toggle on/off
Channel Source Edit	Patch input to channel
Circle Take	Circle take
Com Rtn	Activates Com Rtn
Com Send	Activates Com Send
Com Send (Latch)	Activates Com Send latching operation
Com Send (Momentary)	Activates Com Send momentary operation
Create Sound Report	Creates Sound Report to selected media
Current Take Notes	Edits the current takes notes
Current Take Number	Edits the current takes number
Current Take Scene Name	Edits the current takes scene name
Dante Out Edit	Shortcut to Dante Output Routing screen
Delete Q-mark	Deletes a Q-mark during record, playback, scrub or pause
EQ Mode	Spills EQ parameters over scribble strips, Fader Bank right to view last parameter. Push and hold V-Pot 1 to toggle EQ on/off, push each band's amplitude V-Pot to toggle on/off each band, push each band's Q V-Pot to toggle EQ type Shelf/Peak.
Fader Bank Left	Switches faders to left banks on connected controller
Fader Bank Right	Switches faders to right banks on connected controller
False Take	Activates False Take function
Fast Fwd	Press and hold to fast forward during playback
Fat Ch. Mode	Spills fat channel parameters across scribble strips
Fat Ch. Mode Bus	Spills fat channel bus parameters across scribble strips
Fav HP Preset	Recalls Fav HP Preset from Main Menu>Outputs>HP Presets
Fav Toggle	Emulates Fav toggle
HP Presets Menu	Shortcut to Main Menu>Outputs>HP Presets
HP Volume Lock	Disables/enables the HP knob volume adjustment.
Home	Activates Home screen and Trim knobs mode
Jog is HP	Switches Jog wheel to emulate HP knob
Jog is Select	Switches Jog wheel to emulate Select knob
Jog Wheel Press	Acts as "Select" while using jog wheel

L-ident	Identifies left channel output by varying amplitude vs. right channel with constant amplitude
LR Returns Meter	Activates the returns meter view
Main Mute	Mutes the Bus or Output that the 3rd party Controller > Main Fader is assigned to.
Menu	Emulates the Menu button
Meter	Emulates the Meter button
Mic Toggle	Emulates the Mic toggle
Mix Low Cut Mode	Activates all V-Pots to Low Cut mode on every channel. Push to reset to 0 Hz.
Mix Pan Mode	Activates all V-Pots to Pan mode on every channel. Push to center pan
Mix Trim Mode	Activates all V-Pots to Trim mode on every channel. Push to enter pan mode.
Nav Down	Moves the highlighted selection up one in matrix screens, emulates HP knob down in Home screen
Nav Left	Navigates back to previous screen
Nav Right	Selects the currently highlighted selection
Nav Up	Moves the highlighted selection down one in matrix screens, emulates HP knob up in Home screen
Next Take Notes	Edits the next takes notes
Next Take Number	Edits the next takes number
Next Take Scene name	Edits the next takes scene name
Noise Supp. Menu	Enters the Noise Suppression Menu
Noise Supp. On/Off	Toggles the noise suppression
Notes (Current Take)	Edits the current take's notes
Notes (Follow Stop)	Edits the notes for the Take that is displayed on the Home screen. The Take that is displayed is dependent on the Rec/Play menu > Next Take Display setting.
Notes (Next Take)	Edits the next take's notes
Out Mode	Selects the output masters mode
Play	Plays the last recorded take
Play Remain Time	Selects the remaining time in the LED timecode display
Record	Starts record
Record Folder	Navigates to the record folder
Rewind	Rewinds during playback
Rtn A	Selects Rtn A toggle on/off
Rtn B	Selects Rtn B toggle on/off
Rtn Toggle	Emulates the Rtn toggle
SuperSlot Overview	Opens the SuperSlot Overview screen
Scene Inc	Brings up the Scene Inc Dialog box for incrementing Scene Name according to the setting in Files>Scene Increment Mode (Character, Numeric)
Scene Name (Current Take)	Brings up the Scene Name Edit virtual keyboard screen for editing the current take's scene
Scene Name (Follow Stop)	Brings up the Scene Name Edit virtual keyboard screen for editing the scene of the take that is displayed on the Home screen. The take that is displayed is dependent on the

	Rec/Play menu > Next Take Display setting.
Scene Name (New)	Brings up the Scene Name Edit virtual keyboard screen for adding a new scene name entry.
Scene Name (Next Take)	Brings up the list options for editing the next take's scene.
Select	Selects the currently highlighted selection in menus and matrix screens
Slate	Toggles Slate on/off
Slate (Latch)	Toggles Slate latching operation
Slate (Momentary)	Toggles Slate momentary operation
Stop	Stops playback
SuperSlot Overview	Shortcut to SuperSlot view (when available)
Take List	Brings up the Take List
Take Number (Current Take)	Edits the current take's number
Take Number (Follow Stop)	Edits the take number of the take that is displayed on the Home screen. The take that is displayed is dependent on the Rec/Play menu > Next Take Display setting.
Take Number (Next Take)	Edits the next take's number
Timecode Jam	Brings up the Timecode Jam screen
Toggle Jog is Select	Toggles between Select and HP knob press
Tone	Toggles tone on/off
Tone Toggle	Emulates Tone toggle
* Toggle	Emulates * toggle
** Toggle	Emulates ** toggle

Display Ch. Fader Gains

Selects whether the fader gains are displayed in the controller's display. [Off, On*]

Applies to CL-16 and 3rd party controllers.

Soft Fader/Trim Pickup

[Off*, On] When enabled, physical faders and trims on the 8-Series front panel, CL-16, CL-12, and some 3rd party controllers with non-motorized faders resume gain control only when their physical position reaches the last stored gain value. This prevents sudden jumps in gain levels when setting gains from more than one control interface.

Note: Last stored gain values are held over a power cycle and may require the adjustment of a physical fader or trim control to pickup the last stored gain value.

Note: Soft Fader/Trim Pickup also works in conjunction with the SD-Remote. The 8-Series trim/faders pickup control only once they have reached the last gain set in SD-Remote.

When Soft Fader/Trim Pickup is Off and a controller is connected, the 8-Series front panel controls are disabled unless controlled by SD-Remote. Use SD-Remote Hide Faders function to prevent SD-Remote changing fader gains accidentally.

Note: When a non-motorized fader controller and SD-Remote are both used at the same time, the controller will not soft pickup fader or trim control.

Solo Follows Select

Selects whether solo (PFL) mode is engaged on a channel when pressing "Select" from the controller [Off, On*]. Applies to supported 3rd party controllers and CL-16.

CL-16

Selects CL-16 menu.

1. LED Brightness: 5-100% in increments of 5% (100% is default)
2. LCD Brightness: 5-100% in increments of 5% (100% is default)
3. Long Button Press: 300-1000 ms in increments of 5 ms (500 ms is default)
4. Bank Disable: On or Off (off is default)
5. GPIO Configuration: Opens menu to display GPIO_1 - GPIO_8 (see below for options and details)
6. Channel Colors: Opens a menu to assign background colors to LCD channel strips 1-32.
7. Group Colors: Opens menu to assign Group 1-4 Color (Defaults: 1=Yellow, 2=Orange, 3=Light Blue, 4=Light Green).
Color options: Yellow, Orange, Light Blue, Light Green, Green, Light Brown, Brown, Violet, Pink.
8. Gray Meters: Off or When Disarmed

CL-16 Operation is covered in the CL-16 User Guide.



CL-16 GPIO (General Purpose Input/Output)

The 10-pin Phoenix connector labeled Remote provides eight GPIO ports. These can be configured as simple contact-closure inputs, and to drive low current draw components such as LEDs and logic-controlled powered relays.

CL-16 Remote Pin Functions

Ground (-): for triggering logic-low connections.

1 - 8: Configurable as inputs or outputs, activate high or low, and assigned a function.

+5 V DC: for triggering logic high connections.

Active High inputs trigger when +5V is applied.

Active Low inputs trigger when ground is applied.

Active High outputs go to 5 V when the mapped function is active.

Active Low outputs go to ground when the mapped function is active.

The GPIO lines can supply or sink 10 mA through the series 100 ohm internal resistance. This is not enough to directly drive relays but is enough for driving logic-controlled powered relays.

Pin 10 of the connector supplies 1A at 5V.

GPIO Outputs can be used to drive LEDs with a proper series resistor. Resistor values vary from LED to LED, 470 ohms is a good starting point.

Although the CL-16 has protection against ESD (static electricity), highly inductive loads (like relays, bells etc) may require extra diode protection to protect against inductive voltage spikes. Make sure to protect the CL-16 with an anti-parallel diode across the coil of what is being driven.

CL-16 GPIO Configuration Menu

Input/Output

Toggle on Mic/Tone Switch

Active High/Active Low

Toggle on */** Switch

Defaults

GPIO_1=Record, 2=Play, 3=Stop, 4=None, 5=None, 6=Record, 7=Play, 8=Stop

Available Options

None, Auto Mixer On/Off, Bus Mode, Channel Groups Edit, Channel Sends on Faders, Channel Source Edit, Circle Take, Com Send 1, Com Send 1 (Latch), Com Send 1 (Momentary), Com Send 2, Com Send 2 (Latch), Com Send 2 (Momentary), Com Rtn 1, Com Rtn 2, Create Sound Report, Dante Out Edit, Edit Scene Name, Edit Take Notes, Edit Take Number, EQ Mode, Fader Bank Left, Fader Bank Right, False Take, Fast Fwd, Fat Ch Mode, Fat Ch Mode Bus, Fav HP Preset, Fav Toggle, Home, HP Presets Menu, Jog Is HP, Jog Is Select, Jog Wheel Press, L-Ident, LR Returns Meter, Menu, Meter, Mic Toggle, Mix Low Cut Mode, Mix Pan Mode, Mix Trim Mode, Nav Down, Nav Left, Nav Right, Nav Up, Out Mode, Play, Play Remain Time, Record, Rewind, Rtn A, Rtn B, Rtn C, Rtn Toggle, SL-6 Receiver Overview, Scene Inc, Scene Name, Select, Slate, Slate (Latch), Slate (Momentary), Stop, Take List, Take Notes Edit, Take Number Edit, Timecode Jam, Toggle Jog is Select, Tone, Tone Toggle, *Toggle, **Toggle

CL-16 GPIO Wiring Diagram Example

In this example, an external contact-closure switch starts recording and the GPIO outputs are used to sound a record bell and turn off a lighting fan.

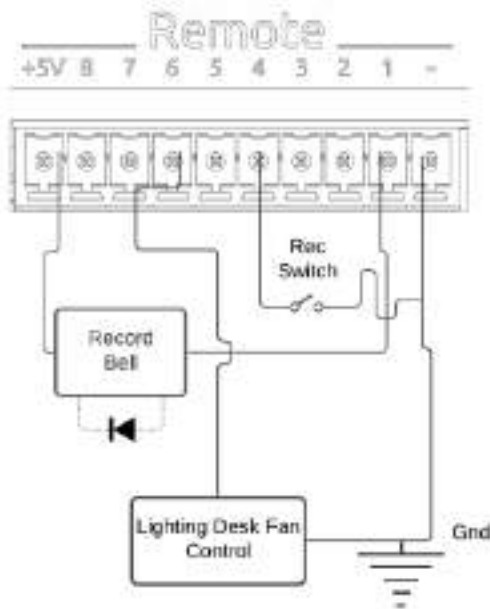

Record bell:

GPIO pin 1 settings:-

- Output
- Active Low
- Record

Record contact-closure switch:

GPIO pin 4 settings:

- Input
- Active Low
- Record

Lighting fan control (Fan requires +5 V on its trigger input to turn off):

GPIO pin 6 settings:

- Output
- Active High
- Record

CL-12

Selects the CL-12 menu. The CL-12 is a 12 channel linear fader controller with control over fader gain, PFL, Arm, EQ, buses, outputs, coms, transport, metadata, and more. For detailed setup and operational information, please refer to the CL-12 User Guide.

Note that the CL-12 Linear Fader Controller cannot be used with another controller.

CL-12 menu settings:

1. L-X2 Level Controls: sets whether the L-X2 pots control bus level or output level or whether they are disabled altogether.
2. L-X2 Metering: sets whether the L-X2 meters display bus or output levels.
3. L-X2 Routing: sets whether L-X2 routing is to buses L-X2 or outputs L-X2.
4. LED Brightness: sets CL-12 LED brightness
5. SEL Follows PFL: selects whether a channel is automatically selected when its PFL is engaged.

Tips: When CL-12 is connected to the 833 trim gains are controlled from the 833.

Slate mic can be toggled on/off by pressing both COM 1 and COM 2 simultaneously.

When adjusting EQ from the CL-12, the EQ values are displayed at the bottom of the 833 meter view.

A USB-A to USB-A cable is required to connect the CL-12.

Pressing stop while in stop will toggle between editing the next take and current take's scene, take and notes metadata.

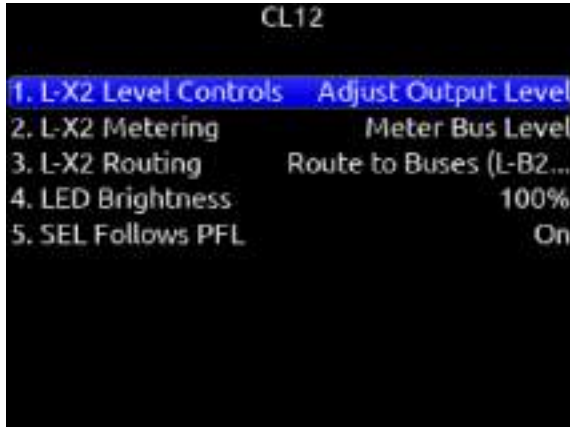

Third Party Controllers

1. Require Shift for Arm: When selected, "Shift" on external control surface must be pressed simultaneously with "Rec" to arm tracks. [Off*, On]. Applies to supported 3rd party controllers only.
2. Require Shift for Mute: When selected, "Shift" on external control surface must be pressed simultaneously with "Mute" to mute channels, buses, and outputs. Applies to supported 3rd party controllers only.
3. Main Fader: Sets which bus or output a third party controller's main fader controls.
4. Multiple Controllers: When multiple controllers are simultaneously connected to the 833 via a USB hub, sets whether they operate in Spill or Individual mode.
 - a. SPILL: In Spill Mode, all MCU controllers connected to the 833 work as one big control surface. All controllers operate in the same mode (e.g. Mix Mode, Bus Mode, Output Mode etc), all channel strips join into a single fader bank spilled across all controllers, and all controlled parameters spill across all available channel strips. For example, with the +4 plugin installed, a setup with two 8-fader controllers spills faders 1-8 to controller 1 and faders 9-12 to controller 2. The USB Hub port number determines which controller is Controller 1 and which is Controller 2. Controller 1 must be connected to a lower USB port number than Controller 2. On most hubs, the USB port numbering is not marked in which case, try the various ports to determine the hub's USB port numbering.
 - b. INDIVIDUAL: In Individual Mode, each controller behaves independently with its own operating mode and fader bank. For example, this allows using one controller for the main channel mix in Mix Mode and a separate controller for setting up IFB feeds in Bus Mode or Bus Sends on Faders Mode. A third controller could be used for output control in Output mode.

Control Modes

A Control Mode determines the function of a controller's faders, VPots, and other buttons.

The VPots are the multi-function encoder knobs positioned above each channel's fader.

Mix Trim Mode (Home). For mixing channels to the main LR bus. Switches faders to channel faders and VPots to channel trims.

Mutes and Solos buttons are channel mutes and solos respectively.

Fat Channel Mode. For editing various channel parameters including Trim, Pan, Source, Delay, Phase, Limiter, HPF, EQ, and Bus Sends.

Mix Pan Mode. For adjusting channel pans by rotating the VPots. Press a VPot to set pan to center. Faders, mutes and solos continue to control the channel mix, mutes and solos.

Mix Low Cut Mode. For adjusting channel low cut frequency by rotating the VPots. Press a VPot to toggle Low Cut On/Off. Faders, mutes and solos continue to control the channel mix, mutes and solos.

Bus Mode. For adjusting Bus levels B1-B4, L,R. Switches faders to Bus faders. Mutes and Solos buttons are Bus mutes and solos respectively.

Bus Sends-on-Faders Mode. Faders are channel sends to the selected bus. Ideal for creating different IFB feeds/mixes.

Channel Bus Sends Mode. VPots adjust a channel's send gains to each bus. Press VPot to toggle between Off, Pre, Post and Send. Rotate VPot to adjust bus send gain. Use the Select buttons to select which channel's send gains to adjust.

Output Mode. For adjusting Output levels X1-X4, L,R. Switches faders to Output level controls. Mute buttons are output mutes.

EQ Mode. For adjusting channel EQ using the VPots. Use the Select buttons to select which channel's EQ to adjust. Faders continue to control the channel mix.

Supported Third-Party Controllers

The 833 supports a variety of third-party external controllers that conform to the MCU protocol. Multiple controllers may be connected simultaneously for extended control. MCU-based controllers not in the list below, may or may not work correctly.

SONOSAX SX-LC8+

Eight channel compact fader bank with faders and channel selects for channels 1-8 plus controls for slate mic, record, and stop. The Mic, Rec, and Stop buttons are mappable to other functions using the Mapping menu.

Ensure the Sonosax is set to USB Midi mode

1. Press and hold buttons 6 + 7 + 8 and connect the USB cable to the 8-Series USB-A port. The mode change is confirmed by a blinking REC
2. Reboot the 8-Series.

Icon Platform M+ and D2 Display

Eight channel fader bank with control over gain, bus, sends, coms, trim and pan. Dedicated Select, Mute, Solo and Arm buttons for each channel. Bank switch between 833 channels 1-8 and 9-12 if the +4 plugin is installed. Icon M+ Operation is covered in the Icon M+ User Guide: <https://cdn.sounddevices.com/wp-content/uploads/2019/05/Icon-User-Guide.pdf>

Icon Platform X+

Eight channel expansion fader bank with single assignable knob and Select, Mute, Solo and Arm buttons.

Icon Platform B+

Assignable illuminated 50 pad button surface. Allows a user to custom map up to 50 functions. Connects via USB-A cable, not mini DIN.

Behringer X-Touch

Eight channel trim and fader panel with master volume and additional mappable buttons. Bank switch between 833 channels 1-8 and 9-12 if the +4 plugin is installed.

Mackie MCU Pro

Eight channel trim and fader panel with master volume and additional mappable buttons. Bank switch between 833 channels 1-8 and 9-12 if the +4 plugin is installed.

Studiologic SL-MixFace

Compact eight-channel trim and fader panel with master fader, transport control, and additional mappable buttons. If the 833 has the +4 plugin installed, bank switch between channels 1-8 and 9-12. **Note:** The Soft Fader/Trim Pickup function does not pickup trim and fader values when going between banks and control modes - adjusting trim or fader after moving from one bank or control mode to another will result in sudden audio level changes.

- Ensure the SL-MixFace is set to REAPER DAW mode.
- The 4 mode buttons (Rec, Mute, Solo, Select) determine the function of the button at the bottom of each channel strip.
- The pots at the top of each channel strip are always mapped to the channel trim gain even though the SL-MixFace top panel marking shows 'PAN'.
- To pause playback, press the stop/playback button. To stop playback, press and hold the stop/playback button.

Note: Since, the SL-MixFace does not have displays for each channel like the CL-16, Waves Fit, Icon, Behringer etc, be aware that there is no indication of what the current Control Mode or Bank is. The pots at the top of each channel change their function based on Control Mode and Bank.

Waves MidiPlus Fit

Sixteen channel trim and fader panel with main fader and additional mappable buttons. Note that the Waves MidiPlus Fit must be running firmware v1.1.3 or later and set to MCU mode. To enter MCU mode, hold down the 'Solo' button of channel 1 and the '2' button of channel 2 simultaneously while turning on the FIT. Refer to the 'Waves MidiPlus Fit Controller for the 8-Series - User Reference' for more information.

Toggle Switch Action

TOGGLE SWITCH ACTION	
1. Mic	Slate
2. Select + Mic	Com Send
3. HP + Mic	No Action
4. Tone	Continuous Tone
5. Select + Tone	L-Ident Tone
6. *	No Action
7. * + Select	No Action
8. * + HP	No Action
9. **	No Action
10. ** + Select	No Action

Mic, Select + Mic, HP + Mic,

Selects Slate, Slate (Latch), Slate (Moment), Com Send, Com Send (Latch), Com Send (Moment), Ch 7 Trim/PFL (latch), Ch 8 Trim/PFL (latch), Ch 7 Fader /PFL (latch), Ch 8 Fader/PFL (latch), Add Q-mark, Delete Q-mark, Create Sound Report, Record Folder, or No Action.

Select + Tone, Tone

Selects Continuous Tone, L-ident Tone, Add Q-mark, Delete Q-mark, Create Sound Report, Record Folder, or No Action.

/*

[Jam Menu, Jam A20-Mini Menu, Circle Take, Slate, Slate (Latch), Slate (Moment), Com Send, Com Send Latch, Com Send Moment, Rtn A, Rtn B, Com Rtn, Automixer On/Off, Noise Suppression On/Off, Take List, Take Notes, Take Number, Ch 7 Trim/PFL (latch), Ch 8 Trim/PFL (latch), Ch 7 Fader /PFL (latch), Ch 8 Fader/PFL (latch), Add Q-mark, Delete Q-mark, Create Sound Report, Record Folder, No Action,

Next Scene Name (Edits the next take's scene name),

Current Scene Name (Edits the current take's scene name and applies that to the next take),

New Scene Name (Creates a new scene name, adds it to the scene name entry list and in record, applies it to the currently recording take and next take. In stop, it is applied only to the next take)]

*** + SELECT**

[Ch 7 Trim/PFL (Moment), No Action]

*** + HP**

[Ch 8 Trim/PFL (Moment), No Action]

**** + SELECT**

[Ch 7 Fader/PFL (Moment), No Action]

**** + HP**

[Ch 8 Fader/PFL (Moment), No Action]

Select + Rtn, HP + Rtn, Rtn

[Rtn, Com Rtn, Fav HP, Ch 7 Trim/PFL (latch), Ch 8 Trim/PFL (latch), Ch 7 Fader /PFL (latch), Ch 8 Fader/PFL (latch), Add Q-mark, Delete Q-mark, Create Sound Report, Record Folder, No Action]

Select + FAV, FAV + HP, FAV

[Rtn, Com Rtn, Fav HP, Ch 7 Trim/PFL (latch), Ch 8 Trim/PFL (latch), Ch 7 Fader /PFL (latch), Ch 8 Fader/PFL (latch), Add Q-mark, Delete Q-mark, Create Sound Report, Record Folder, No Action]

Menu + PFL Switch Action

Menu+PFL Switch [1-6]

[Power Menu, Channel Setup Menu, Channel Grouping, Channels 7-8 Menu, Buses Menu, Outputs Menu, Lr,X1-X4 Output Routing, L Out, R Out, X1 Out, X2 Out, X3 Out, X4 Out, HP Presets, Limiters Menu, Meter Presets Menu, Meter Preset 1, Meter Preset 2, Meter Preset 3, Meter Preset 4, Meter Preset 5, Meter Preset 6, Timecode/Sync Menu, Jam Timecode, Set Generator TC, Set Generator Ubits, Lemo Options, Record,Play Menu, Track To Media, Files Menu, File List, Take List, File Name Format, Sound Report Info, Slate/Coms/Returns Menu, Slate Routing, Com Send Routing, System Menu, Tone Setup, Notification Bells, Brightness, Time/Date Menu, Toggle Switch Actions, Menu+PFL Actions, Controllers Menu, Auto Mixer ON/Off, Noise Suppression menu, Edit Scene Name, Take Number, Take Notes, Scene Name, Record Folder, SuperSlot Overview]

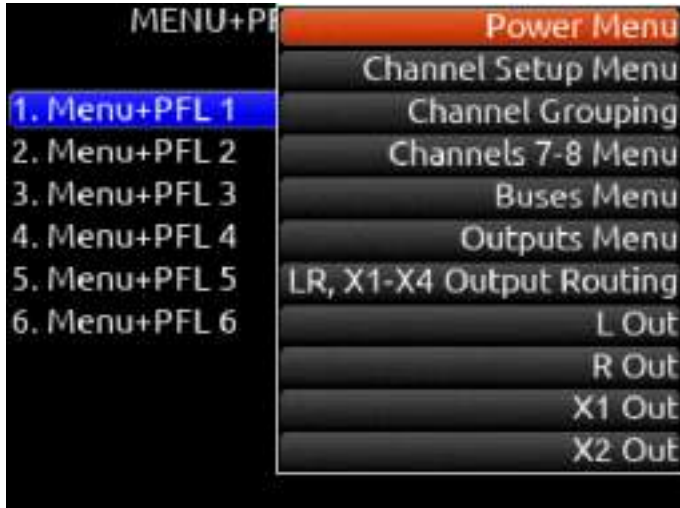

Front Panel Shortcuts

The Menu + PFL Shortcuts are set by default. They can be customized by going to System > Menu + PFL Switch Action.

Menu + PFL Shortcuts	Action
Menu + PFL 1	Power
Menu + PFL 2	Channel Setup Menu
Menu + PFL 3	Channels 7-8 Menu
Menu + PFL 4	Buses Menu
Menu + PFL 5	Outputs Menu
Menu + PFL 6	Limiters Menu

Toggle Switch Shortcuts	Action
Mic Toggle	As defined in the System/Toggle Switch Action menu. Default: Slate
Sel + Mic Toggle	As defined in the System/Toggle Switch Action menu. Default: Com Send
*/** Toggle	As defined in the System/Toggle Switch Action menu. Default: No Action
Rtn Toggle	As defined in the System/Toggle Switch Action menu. Default: Return
Sel + Rtn Toggle	As defined in the System/Toggle Switch Action menu. Default: No Action
HP + Rtn Toggle	As defined in the System/Toggle Switch Action menu. Default: No Action
Fav Toggle	As defined in the System/Toggle Switch Action menu. Default: Fav HP
Sel + Fav Toggle	As defined in the System/Toggle Switch Action menu. Default: Com Rtn
HP + Fav Toggle	As defined in the System/Toggle Switch Action menu. Default: No Action

Other Shortcuts	Action
Channel screen, then hold PFL for >1 sec	Edits Channel (Track) Name
Meter + Rotate HP knob	Zooms meter scale
Meter + Rotate Select knob	Adjusts LCD brightness
Meter + Select or Select + Meter	Arm or disarm Selected track
Meter + HP press	Accesses SuperSlot menu
HP + PFL 1-6	Selects HP Preset 1-6
Sel + PFL 1-6	Selects Bus 1-4, L,R
Meter + PFL 1-6	Selects Meter Preset 1-6
* Toggle + PFL 1-2	Selects Channel Screen/PFL 7-8

HP + Left on Transport Control	False Take
Sel + Fav Toggle	As defined in the System/Toggle Switch Action menu. Default: Com Rtn 1
HP + Fav Toggle	As defined in the System/Toggle Switch Action menu. Default: Com Rtn 2
Sel + Tone (hold)	L-Ident Tone
HP + Right Transport Control	Scene Increment
Sel + Transport Control Right	Add Q-mark
Sel + Transport Control Left	Delete Q-mark
Sel + HP	Toggle Daylight Mode

USB Keyboard

A USB keyboard may be connected to the 833 via the USB-A port. The keyboard may be used for metadata entry as well as the following shortcuts:

Keystroke	Description
F1	Enters Main Menu
F2	Enters Take List
F3	Toggles Meter Views
F5	Emulates Mic toggle
F6	Emulates Tone toggle
F7	Emulates * toggle
F8	Emulates ** toggle
F9	Emulates Rtn toggle
F10	Emulates Fav toggle
F12	Returns to LR, 1-8 Meter View
1,2,3...8	Enters Channel Screens 1-8 respectively
Ctrl+R	Record
Ctrl+S	Stop
Space Bar	Play/Pause
Up arrow	Emulates HP knob rotate clockwise in most screens except channel screen where it emulates the Sel knob rotate clockwise. Channel screen and matrix screens: navigates up HP vol in home screen, row selection in menus, parameter adjust
Down arrow	Emulates HP knob rotate counter-clockwise in most screens except channel screens where it emulates the Sel knob rotate counterclockwise Channel screen and matrix screens: navigates down HP vol in home screen, row selection in menus, parameter adjust
Enter	Home Screen: Emulates HP knob press i.e. HP Monitor Source Select List Menu screens: Emulates HP knob press i.e. Activates selection Channel screens: Emulates HP knob press Virtual Keyboard: OK
Ctrl+Up arrow	Emulates Sel knob rotate clockwise
Ctrl+Down arrow	Emulates Sel knob rotate counterclockwise
Ctrl+Enter	Emulates Sel knob press
Ctrl+P	Screenshot of current screen
Q	Add Q Mark
Delete	Delete Q Mark

X-KEYS® PROGRAMMABLE KEYPADS, STICKS & KEYBOARDS

X-keys include a variety of compact, tactile input devices that can be programmed to emulate USB keyboard commands. Their various buttons and tactile controls are programmed via P.I. Engineering's MacroWorks Windows software. When mapped as individual commands or as macro commands to 833's USB Keyboard shortcuts listed above, they offer quick-access to many functions including Record, Stop, Play, and many more.

To use with 833, the X-Keys device must be connected to the USB-A port.

Please visit P.I. Engineering's website for more information

SD-Remote



All SD-Remote pictures in this section were captured with SD-Remote connected to a Scorpio. Views and navigation are the same on the 833 except for fewer channels, buses, and outputs.

SD-Remote is a mobile device application designed to pair with the 833. SD-Remote is available for Android tablets and phones in the Google Play Store or as an APK from www.sounddevices.com, and for iPhone and iPad in the App Store. An Android tablet can be hardwired to the 833 via USB or wirelessly connected via Bluetooth LE. An Android phone, iPhone, or iPad wirelessly connects to the 833 via Bluetooth LE. SD-Remote offers control and display parameters, including the following:

1. Channel, Bus, and Output Meters
2. Channel, Bus, and Output Names
3. Channel, Bus, and Output Source selection
4. Channel, Bus, and Output Mutes
5. Channel and Bus Solos
6. Channel and Bus Record Arm/Disarm
7. Channel Trim Gains, Fader Gains, and Pans
8. Bus and Output Faders
9. Channel, Bus, and Output Linking
10. Channel and Output Delay
11. Channel HPF, Iso, Phase, Limiter
12. Transport-dependant Output Muting
13. Record, Stop, Play, FFWD, REW
14. False Take and Circle Take
15. Take List and Metadata Editing
16. Timecode
17. Routing Matrix
18. Reports
19. File Transfer

First download and install the SD-Remote app from the Google Play Store or App Store.

SD-Remote requires the following minimum operating systems:

- iPad running iOS 12 or iPadOS 13+
- iPhone running iOS 12+
- Android tablets require Android 6 Marshmallow for USB connection. The device needs to support MIDI and BLE in order to operate.
- Android phones and tablets require Android 7 Nougat when connecting via Bluetooth LE. The device needs to support MIDI and BLE in order to operate.

Note: It is recommended to close the SD-Remote app before powering down the 8-Series. This will help prevent the SD-Remote app not connecting after the next boot up. Should SD-Remote not connect to the 8-Series, FULLY close then restart the app.

USB Setup Procedure for Android

1. Connect Android tablet to the 8-Series Mixer-Recorder via USB-A port.
2. Open the SD-Remote app, access Settings [gear icon], and choose to connect via USB.
3. On the Android tablet, open the quick settings drop down menu.
4. Touch "USB Android System" twice to open "Use USB to" dialog box.
5. Touch "Connect a MIDI device."

"No USB Connection" popup will appear when SD-Remote does not detect presence of an 8-Series Mixer-Recorder.

Bluetooth Setup Procedure for Android

1. On the 8-Series Mixer-Recorder, set Bluetooth to On in the System>Bluetooth menu.
2. Open the SD-Remote app, access the settings tab, and choose "Connect via Bluetooth".
3. Access any Metering tab and touch the Sound Devices logo button to display a list of 8-Series devices that can be connected to via Bluetooth. When the Devices Found list is shown, Bluetooth connection to the currently selected device is stopped.
4. Connect to a specific 8-Series device by touching the Bluetooth button next to its serial number. 'Connecting...' is displayed. Wait for connection to take place. When connection is successful, the SD-Remote meter view is displayed.

"No Bluetooth Connection" popup will appear when SD-Remote does not detect presence of the selected 8-Series device.

For optimal Bluetooth LE connection, the Sound Devices XL-ANT2.4 Antenna must be fitted to the SMA port of the 8-Series device.





Bluetooth Setup Procedure for iPad and iPhone

1. On the 8-Series Mixer-Recorder, set System>Bluetooth to On.
2. Open the SD-Remote app and touch the Sound Devices logo button to display a list of 8-Series devices within Bluetooth LE range. When the Devices Found list is displayed, Bluetooth LE disconnects from the previously connected 8-Series Mixer-Recorder.
3. Connect to a specific 8-Series device by touching the serial number. 'Connecting...' is displayed. When connection is successful, the SD-Remote meter view is displayed.
- 4.

"No Bluetooth Connection" popup will appear when SD-Remote does not detect presence of the selected 8-Series device.

For optimal Bluetooth LE connection, the Sound Devices XL-ANT2.4 Antenna must be fitted to the SMA port of the 8-Series device.



Setting a Password

To prevent unauthorized access to the 8-Series Mixer-Recorder via Bluetooth LE:

1. Navigate to System-Bluetooth-Set Password.
2. Create a password using the on-screen keyboard.
3. Use the Fav toggle to save the password.
4. Press "Ok" in the "Set New Password" dialog box.
5. Connect your tablet via SD-Remote to the 8-Series device as described above.
6. Enter the password and press "Enter" to allow connection.
7. Toggle "Remember Password" to allow the mobile device to connect without reentering password.



To Remove A Password

1. In the 8-Series menu, navigate to System-Bluetooth-Clear Password.
2. Press "Ok" in the "Clear existing password" dialog box.

Channel Meters View

Tablet



1. Fat Channel Screen Access
2. Mute
3. Track Arm
4. Channel Meter
5. Channel Trim
6. Channel Fader
7. Channel Name
8. Device Connection
9. Current Take Metadata
10. Left & Right Mix Meters
11. Information Window
12. Next Take Metadata
13. Transport Bar
14. Transport Lock
15. Arm Lock
16. Navigation Bar

Phone

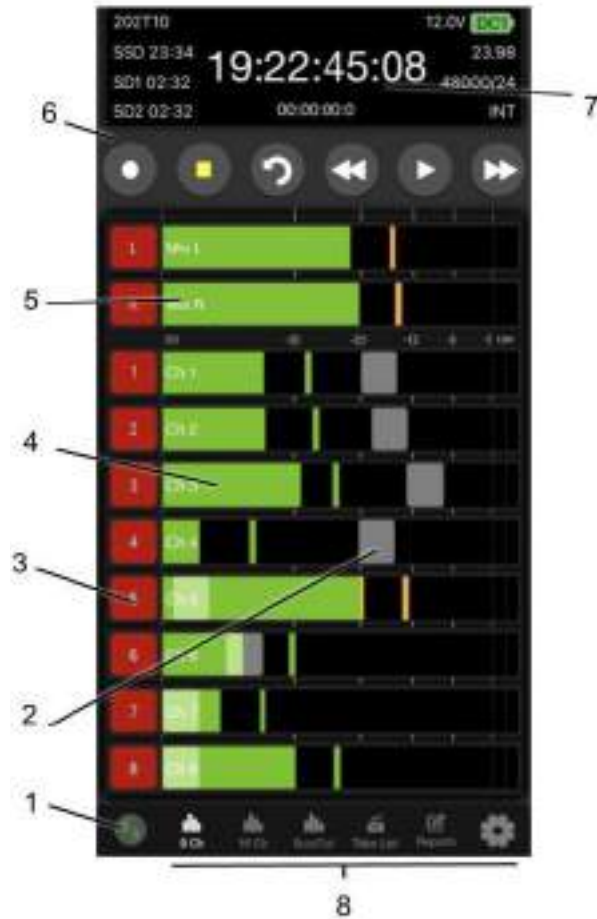

1. Device Connection
2. Channel Fader
3. Track Arm
4. Channel Meter & Channel screen Access
5. Left & Right Meters
6. Transport Bar
7. Information Window
8. Navigation Bar

Device Connection

Touch the Sound Devices insignia to view a list of available 8-Series Mixer-Recorders to connect via Bluetooth or USB. If already connected to a device, a 'Break Connection' popup will appear to prevent accidental disconnection.

Information Window

Displays current take name, power source icon with remaining voltage (remaining percentage and time with Smart Batteries), timecode, absolute time, remaining time of SSD, SD1, and SD2, Timecode frames per second, sample rate and bit depth, and sync source. Display turns red in record and green during playback.

Navigation Bar

Allows quick access to various meter views, Take List, Sound Reports, and Settings. Tablet views allow for quick access to all available meter screens. Phone view displays 8 (or 12 with the +4 plugin) Channel Metering. Swipe up on the meters to view the next bank of meters.

Transport Bar

Record, Stop, False Takes, Play, Rewind, and Fast Forward buttons.

Current Take Metadata (Tablet)

Displays and allows for editing of Current Take Scene, Take, and Notes. This information is also available in the Take List. Phone views do not have access to this field on Meters view.

Next Take Metadata (Tablet)

Displays and allows for editing of Next Take Scene, Take, and Notes. This information is also available in the Take List. Phone views do not have access to this field on Meters view.

Left & Right Mix Meters

Displays audio activity and arm status on the Left and Right Mix Bus.

Channel Name (Tablet)

Touch to edit the channel's name. Blue fill indicates the channel is muted.

Channel Name (Phone)

Displays the channel's name. The name can be edited from the Fat Channel Screen. Blue fill indicates the channel is muted.

Fat Channel Screen Access (Tablet)

Touch to access the channel's Fat Channel screen. Yellow fill indicates the channel is PFL'd.

Channel Meter & Fat Channel Screen Access (Phone)

Displays the channel's audio activity, touch the meter to access the Fat Channel Screen. A white border around the meter indicates the channel is PFL'd.

Channel Trim (Tablet)

Touch and drag to adjust a channel's trim gain. On a tablet, the channel name cell above the meter displays the gain dB value as the trim is adjusted. To prevent accidental trim gain control, hide the trims by setting Hide Channel Trims to On in the Settings tab.

Channel Fader

Touch and drag to adjust a channel's fader gain. On a tablet, the channel name cell above the meter displays the gain dB value as the fader is adjusted. To prevent accidental fader control, hide the faders by setting Hide Channel Faders to On in the Settings tab.

Track Arms

Touch to arm/disarm channels. To arm/disarm multiple channels during record, touch and hold one arm button, then toggle others. A new split take will only be created once the held arm button is released.

Transport lock (Tablet)

To prevent accidental transport commands, enable the Transport Lock button.

Arm lock (Tablet)

To prevent accidental arming or disarming, enable the Arm Lock button.

Fat Channel Screen

From the Fat Channel screen, view a channel's audio activity, arm/disarm the isolated track for recording, edit the track name, set trim gains, fader gains, pan, mute, PFL, channel source, HPF, Iso, delay, phase, limiter, and linking. Tablet views allow for direct access to other Fat Channel screens via the tabs on the bottom of the screen.



Bus Meters View

The Bus Meters view is similar to the Channel Meters view except that it displays metering and control for buses. To access on a tablet, tap the Buses Tab. To access on a phone, tap the Bus/Out Tab



Fat Bus Screen

A buses detailed settings (Name, Gain, Limiter, Mute, AFL, Linking, and Routing) can be configured from its Fat Bus screen which is accessed from the Bus Meters view as follows:

1. For a tablet, tap its Fat Bus Screen Access touch zone at the bottom of each Bus strip.
2. For a phone, tap its Bus meter.



Output Meters View

The Output Meters view is similar to the Channel and Bus Meters view except that it displays metering and control for outputs. To access on a tablet, tap the Outputs Tab. To access on a phone, tap the Bus/Out Tab and swipe up.



Fat Output Screen

An output's detailed settings (Name, Gain, Delay, Mute, Linking, Rec/Stop/Play Auto-mute, and Routing) can be configured from its Fat Output screen which is accessed from the Outputs (tablet) or Bus/Out (phone) Meters view as follows:

1. For a tablet, tap its Fat Out Screen Access touch zone at the bottom of each Output strip.
2. For a phone, tap its Output meter. First swipe up in the Bus/Out tab to display the Output meters.



Routing Matrix (tablet only)

Tap the Routing tab. Provides a one-stop view for routing for all channels, busses, and outputs



Tap the Multiple Tabs button in the bottom right hand corner to allow more than one To/From group to be displayed at once. Swipe view to display other rows and columns in the routing matrix. Collapse groups by tapping '-'. Expand groups by tapping '+'. Tap a square cell to route/unroute a source to a destination. Pre-fade routing = green, Post-fade routing = orange, Bus send routing = light blue, Unrouted = gray cell.

Take List

From the Take List, enter metadata for Next, Current, or previous takes, select a take for playback, or view take information. The Take List View on a Tablet displays the Take List, Take Edit, and Take Info windows simultaneously. The Take List on a phone displays the Take List, selecting a take will enter the Take Edit view, selecting the 'i' icon will display the Take Info view. In stop mode, touch a take's play icon to play back that take.

Next Take Metadata

Edit scene, take, sticky notes, notes, and track names for the upcoming take.

Current and Previous Take Metadata

Edit scene, take, notes, track names, and circle the current or previously recorded take.

Take Info

Displays timecode, user bits, frame rate, duration, media, roll/folder, date, time, sample rate, bit depth, channels, and whether the take is poly- or monophonic.

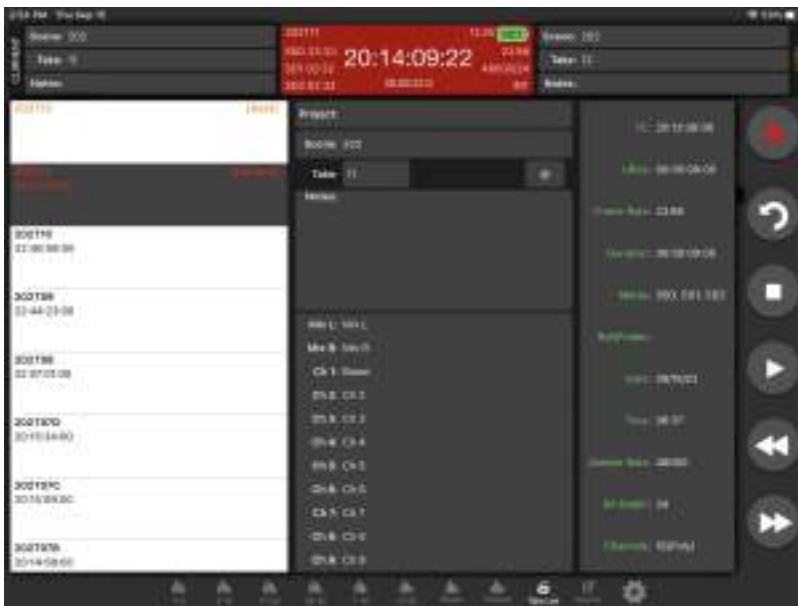

Sound Report

Create Sound Report

1. Touch "Reports" icon on the bottom of the screen.
2. Select the source(s) from which the desired info resides. Sibling folders (folders at the same directory level) may be included in the same report by selecting "Sibling Folders."
3. Select which Sound Report format to send. Select Email CSV and/or Email PDF.
4. Select whether to send the CSV and PDF files individually or all as a single compressed .zip file.
5. Touch the Create Report button. Sound Reports will be shared via email while simultaneously being created on the selected source drives.



To create a report from a different day's folder than the currently active one, go to the 888's Take List > Next Take > Rec Folder and highlight the shoot day folder you want to create the report for, then press 'Set Folder'. '[current]' in orange text appears after the name of the current record folder.

To merge several folders or days into one sound report in SD-Remote, activate 'Sibling Folders'. This will print all contents of all folders at the same directory level as the current record folder creating a sound report.



Settings

SD-Remote Version

Displays the version number.

Connect Via (Android Tablet)

Select whether to connect via USB or Bluetooth. If Bluetooth is selected, use the Connect Icon on the Meter views to connect to a device.

Hide Faders

Turn On to hide faders in the Meter views. Faders are still available in the channel screen.

Hide Channel Trims (Tablet)

Turn On to hide faders in the Meter views. Faders are still available in the channel screen.

Hide Channel Mute (Tablet)

Turn On to hide faders in the Meter views. Faders are still available in the channel screen.

Auto AFL Bus

Determines whether a bus should automatically be solo'd when accessing its Fat Bus Screen. When set to Off, the bus will not automatically be soloed.

Auto PFL Channel

Determines whether a channel should automatically be solo'd when accessing its Fat Channel Screen. When set to Off, the channel will not automatically be soloed.

Meter View Transport Lock (Phone)

Enable to prevent accidental transport commands.

Meter View Arm Lock (Phone)

Enable to prevent accidental arming disarming in the Meter views. Track arming is still available in the channel screen.

File Transfer Mode

Touch to put the 8-Series into File Transfer Mode.





Quick Setup

Load Global Settings

Selects a saved settings file for loading. [User-saved Global settings]. Only settings files created using the 833 can be loaded, not other 8-series models.

Save Global Settings

Saves Global settings to various destinations. [SSD Drive (internal), INT1-4 (internal), SD1 and SD2]

Load Factory Settings

Selects factory settings to be loaded for entire unit.

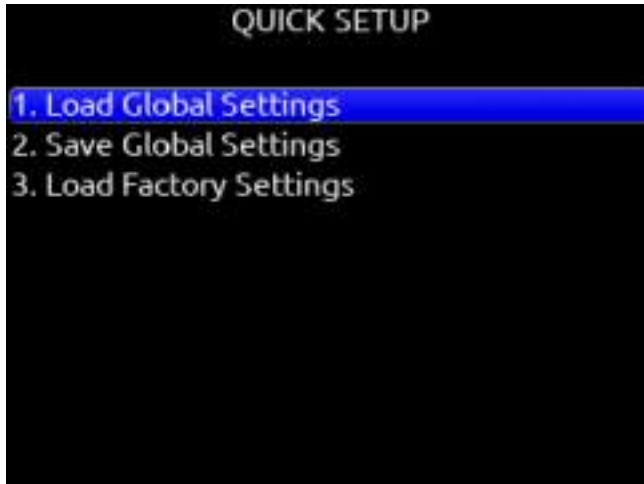

USB-A

USB-A allows multiple devices to be used to control and monitor various functions of the 833. Should multiple devices be used simultaneously, the use of a USB-A type hub is required.

USB-C

USB-C allows for high-speed file transfer between a computer and any of the 833's media.

Note: All other functionality is suspended in USB File Transfer mode.

2-In 2-Out USB audio is available via the USB-C port on the 833. All routing is handled through the channel and output routing matrices. No special drivers are needed as the built-in OS drivers will work properly.

Windows OS users - 96kHz max sample rate, MacOS users - 192kHz max sample rate.

USB Audio is supported for Windows 10 and above.

Specifications

Specifications are subject to change without prior notice.

For the latest information available on all Sound Devices products, visit our website: www.sounddevices.com

Frequency Response

10 Hz to 80 kHz \pm 0.5 dB (192 kHz sample rate, re 1 kHz)

THD + Noise

0.005% max (mic in, 1 kHz, 22 Hz–22 kHz BW, trim at 20, fader at 0, -10 dBu in)

Equivalent Input Noise

-131 dBV (-129 dBu) max (mic in, A-weighting, 76 dB gain, 150 ohm source impedance)

A/D converters

Multi-stage 32-bit converters, 140 dB A-weighted dynamic range

Sampling rates 44.1 kHz, 47.952 kHz, 48 kHz, 48.048 kHz, 96 kHz, 192 kHz

Processing Engine

Highly extensible, full FPGA-based audio processing, 3 FPGAs

Six-way ARM multiprocessor system

64-bit audio processing precision

Inputs

Mic/Line inputs: 6 total, all fully featured; 3 on full-size XLR, 3 on TA3

Mic-level inputs: (XLR, TA3): Class-A, discrete differential long-tail pair, 4k ohm input impedance

Line-level inputs: (XLR, TA3,): active-balanced, 4k ohm input impedance

48V phantom: full 10 mA to all 6 inputs simultaneously

8 Total analog inputs: 6 mic-line inputs, 2 on returns

AES3 or AES42 available on XLR input 1

AES42: +10 V, 250 mA available, mode-1, auto-ASRC

USB Audio: 2 inputs

A20-Nexus: 8 inputs

SL-2 inputs: SuperSlot or UniSlot

Aux (3.5 mm): unbalanced 2-channel, 4k ohm input impedance

Com Rtn (TA3, 3.5mm) balanced, 1-channel, 8k ohm input impedance

External Slate Mic (TA5): balanced, 8k ohm input impedance, menu-selectable 12 V phantom

Maximum Input Level

Mic: +8 dBu (2.0 Vrms)

Line: +28 dBu (19.5 Vrms)

Aux: +18 dBu (6.2 Vrms)

Com Rtn: +24 dBu (12.3 Vrms)

External Slate Mic: +12 dBu (3.2 Vrms)

High-Pass Filters

Adjustable 10 Hz to 320 Hz, 18 dB/oct. 1st stage analog (before preamp), 2nd stage digital.

Limiters

Limiters available at all channels, buses, headphones, for all sample rates

Analog first stage, all subsequent stages digital

Attack time: adjustable 1 to 200 ms

Release time: adjustable, 50 ms to 1000 ms

Threshold: adjustable, -2 dBFS to -12 dBFS

Selectable ratio: inf:1, 20:1, 18:1, 16:1, 14:1, 12:1, 10:1

Knee: soft, hard

Compressors

Compressors available at all channels (pre- or post-fade) and buses for all sample rates
Attack time: adjustable, 1 to 200 ms
Release time: adjustable, 50 ms to 1000 ms
Threshold: adjustable, 0 dBFS to -40 dBFS
Selectable ratio: adjustable, 1:1 to 20:1
Knee: soft, hard

Channel Delay

Channel Adjustable 0-50 ms

Maximum Gain

Trim stage (mic input): 76 dB
Trim stage (line input): 50 dB
Fader stage: 16 dB
Bus stage: 16 dB
Headphone stage: 20 dB
Mic-to-Line: 108 dB
Mic-to-Headphone: 112 dB
TA5 (along with mic input pins) for single connection to headset + mic
High output, 4 ohm output impedance, 400 mW + 400 mW at each connector, all individually driven
Compatible with headphones of any impedance

Buses

6 Buses (L, R, 1-4)
Left and Right Mix Bus receives post-fade isolated channels. Optional NoiseAssist plugin instances can be applied to any bus.
Buses 1-4 can receive pre-fade, post-fade, or independent send level from isolated channels, Return, and Com Return.

Outputs

XLR (L, R) active-balanced, 250/3.2k/120 ohms (mic/-10/line)
TA3 (X1/X2) active-balanced, 250/3.2k/120 ohms (mic/-10/line)
3.5mm (X3/X4): unbalanced, stereo, 1.8k ohms

Output Delay

Output Adjustable 0-500 ms

Headphone Outputs

¼", 3.5 mm
TA5 (along with mic input pins) for single connection to headset + mic
High output, 4 ohm output impedance, 400 mW + 400 mW at each connector, all individually driven
Compatible with headphones of any impedance

Maximum Output Level

(all into 10k load)
Line: +20 dBu (7.8 Vrms)
"-10": +6 dBu (1.5 Vrms)
Mic: -20 dBu (0.078 Vrms)
X3/X4 Out: +6 dBu (1.5 Vrms)
Headphone outputs (¼", TA-5): +14 dBu (4.0 Vrms)

Digital Outputs

AES3 transformer-balanced, in pairs; 1-2 (XLR-L), 3-4 (XLR-R), 110 ohm, 2 V p-p, AES and S/PDIF compatible

Recording

Internal 256 GB SSD; two removable SD Cards
10% over-provisioned for optimum performance
Selectable bit depth: 16 or 24-bit fixed; 32-bit floating point (ISOs only)
Simultaneous recording to internal SSD and the two SD cards
exFAT formatting
12 tracks (8 iso channels, 4 buses)
Broadcast WAV monophonic and polyphonic file format

64-bit WAV (RF64) monophonic and polyphonic; support for files > 4 GB
AAC 2 track at 48 kHz, selectable bit rate 32, 64, 128, 192, 256 kbps

Automatic Mixing

Dugan Automixing for up to 8 channels on left and right mix bus

Noise Suppression

Via optional paid Sound Devices NoiseAssist or CEDAR sdnx Plugins

Two, four, or eight instances of Noise Suppression can run on any combination of isolated channels or buses.

Attenuation range: 0-20 dB

NoiseAssist operates with sampling rates of 44.1 kHz to 48.048 kHz.

CEDAR sdnx operates with sampling rates of 44.1 kHz to 96 kHz.

NoiseAssist audio path latency: 0.77 ms @ 48kHz

CEDAR sdnx audio path latency: 0.27 ms @ 48kHz, 0.14ms @ 96kHz

USB

USB-C (USB 3.1 type 1) for file transfer of internal SSD, both SD Cards

USB-C 2-in/2 out audio streaming

USB-A host for keyboard, external controller, external USB hubs supported for connecting multiple devices

Timecode and Sync

Modes Supported: Off, Rec Run, Free Run, 24h Run, External, including External Auto-Record and Continuous modes.

Frame Rates: 23.98*, 24, 25, 29.97 DF, 29.97 ND, 30 DF, 30 ND

Sample/Timecode Accuracy: 0.1 ppm (0.25 frames per 24 hours)

Timecode Input: 20k ohm impedance, 0.3 V - 3.0 V p-p (-17 dBu - +3 dBu)

Timecode Output: 75 ohm impedance, 5 V p-p (+7 dBu)

Word Clock Input: 10k/75 ohm selectable impedance,

1-5 V p-p input sensitivity

Word Clock Output: 75 ohm impedance, 5 V p-p output, at SR

Remote Control

Sound Devices CL-16 Linear Fader Controller

Sound Devices CL-12 Linear Fader Controller

USB MIDI MCU Control - supported 3rd party fader controllers

SD-Remote Android Tablet app via USB or Bluetooth LE

SD-Remote Android Phone app via Bluetooth LE

SD-Remote iPad and iPhone app via Bluetooth LE

USB Keyboard

External Timecode Record Trigger

File Delivery to Cloud

Compatible with Viviana Cloud

LCD

320x240, Transflective, excellent sunlight visibility

Larger touchscreen display available via SD-Remote app

Power

External: 10-18 V input on locking TA4 connector,

pin-4 = (+), pin-1 = (-)

Dual rear-mount Sony-style L-mount batteries with chargers

Current Draw, at 12V no battery charging:

All mic preamps off: 730 mA

All mic preamps on: 920 mA

All mic preamps on, 192 kHz sample rate, recording to internal SSD and 2 SD Cards: 1.07 A

Intelligent power-down of unused mic preamps and other internal circuits

Smart Battery telemetry supported via DC Input

Environmental

Operating: -20° C to 60° C, 0 to 90% relative humidity (non-condensing)

Storage: -40° C to 85° C

Dimensions (H x W x D)

5.1 cm x 22 cm x 17 cm;
(2.0 in. x 8.7 in. x 6.6 in)

Weight

2.75 lbs (unpackaged, without batteries)
1.25 kg (unpackaged, without batteries)

Legal Notices

FCC & ISED Compliance Statements



This device complies with part 15 of the FCC Rules. Operation is subject to the following two conditions:

(1) This device may not cause harmful interference, and (2) this device must accept any interference received, including interference that may cause undesired operation.

Changes or modifications not expressly approved by the manufacturer could void the user's authority to operate the equipment.

This device contains transmitter module FCC ID: XF6-M7DB6

This device contains transmitter module IC: 8407A-M7DB6

FCC Interference Statement

This equipment has been tested and found to comply with the limits for a Class B digital device, pursuant to part 15 of the FCC Rules. These limits are designed to provide reasonable protection against harmful interference in a residential installation. This equipment generates, uses and can radiate radio frequency energy and, if not installed and used in accordance with the instructions, may cause harmful interference to radio communications. However, there is no guarantee that interference will not occur in a particular installation.

If this equipment does cause harmful interference to radio or television reception, which can be determined by turning the equipment off and on, the user is encouraged to try to correct the interference by one or more of the following measures:

- Reorient or relocate the receiving antenna.
- Increase the separation between the equipment and receiver.
- Connect the equipment into an outlet on a circuit different from that to which the receiver is connected.
- Consult the dealer or an experienced radio/TV technician for help.

FCC & ISED User Statement

This device complies with FCC and ISED RF exposure limits for general population / uncontrolled environments.

Cet appareil est conforme à la norme FCC et ISED les limites d'exposition pour la population générale / l'exposition incontrôlée.

A separation distance of at least 20cm must be maintained between the antenna and all persons. This device must not be co-located with any other antenna or transmitter.

This device (containing FCC ID: XF6-M7DB6, IC: 8407A-M7DB6) has been approved to operate with the antenna type listed below:

Type: 2.4/5.8 GHz Dipole Antenna

Gain: 3.8 dBi (2.4 GHz), 5.5dBi (5.8 GHz)

No change to the antenna type is permitted. Any change to the antenna could result in the device exceeding the RF exposure requirements and void the user's authority to operate the device.

This Device complies with Industry Canada License-exempt RSS standard(s). Operation is subject to the following two conditions: 1) this device may not cause interference, and 2) this device must accept any interference, including interference that may cause undesired operation of the device.

Cet appareil est conforme avec Industrie Canada, exempts de licence standard RSS (s). Son fonctionnement est soumis aux deux conditions suivantes: 1) ce dispositif ne peut pas causer d'interférences, et 2) ce dispositif doit accepter toute interférence, y compris les interférences qui peuvent causer un mauvais fonctionnement de l'appareil.

Incorrect use of batteries poses a danger of explosion. Replace only with the same or equivalent type.

Properly recycle batteries. Do not crush, disassemble, incinerate, dispose in a fire or expose batteries to high temperatures.

Declaration of Conformity



Declaration of Conformity

Manufacturer's Name: Sound Devices, LLC
Manufacturer's Address: E7556 State Road 23 and 33
Reedsburg, WI 53959 USA

Declares under sole responsibility that the product as delivered

Product Name: 833
Model Number: 833
Description: Mixer-Recorder
Product Options: This declaration covers all options of the above product.

complies with the essential requirements of the following applicable European Directives, and carries the CE marking accordingly:

Radio Equipment Directive (2014/53/EU)
Article 3.1b:
ETSI EN 301 489-17 v3.1.1
EN 55032:2012
EN 55032:2/AC:2013
CISPR 32:2012
EN 55103-2:2009
Article 3.2:
ETSI EN 300 328 v2.1.1

This Declaration of Conformity applies to the above-listed product(s) placed on the EU market after:

September 12, 2019

Date

Matt Anderson - Sound Devices, LLC President

Warranty

Sound Devices, LLC warrants the items listed above against defects in materials and workmanship for a period of ONE (1) year from date of original retail purchase. Users who register their product directly with Sound Devices Technical Support using the online form or by phone, will receive an additional ONE (1) year of warranty coverage, extending the complete warranty period to TWO (2) years from the date of original retail purchase. In order to extend the warranty coverage period, registration must be completed within the initial ONE (1) year warranty period. Products must be purchased through authorized Sound Devices resellers to qualify for Warranty coverage. Damage resulting from the opening of a Sound Devices product or attempted repairs by a non-authorized Sound Devices repair technician will void warranty coverage.

This is a non-transferable warranty that extends only to the original purchaser. Sound Devices, LLC will repair or replace the product at its discretion at no charge. Warranty claims due to severe service conditions will be addressed on an individual basis.

THE WARRANTY AND REMEDIES SET FORTH ABOVE ARE EXCLUSIVE. SOUND DEVICES, LLC DISCLAIMS ALL OTHER WARRANTIES, EXPRESS OR IMPLIED, INCLUDING WARRANTIES OF MERCHANTABILITY AND FITNESS FOR A PARTICULAR PURPOSE. SOUND DEVICES, LLC IS NOT RESPONSIBLE FOR SPECIAL, INCIDENTAL, OR CONSEQUENTIAL DAMAGES ARISING FROM ANY BREACH OF WARRANTY OR UNDER ANY OTHER LEGAL THEORY. Because some jurisdictions do not permit the exclusion or limitations set forth above, they may not apply in all cases.

For all service, including warranty repair, please contact Sound Devices for an RMA (return merchandise authorization) before sending your unit in for repair. Product returned without an RMA number may experience delays in repair. When sending a unit for repair, please do not include accessories, including SSD drives, CF cards, batteries, power supplies, carry cases, cables, or adapters unless instructed by Sound Devices. Sound Devices repairs and replacements may be completed using refurbished, returned or used parts that have been factory certified as functionally equivalent to new parts.

Sound Devices, LLC

Services Repair RMA #XXXXX

E7556 State Road 23 and 33
Reedsburg, WI 53959 USA
Telephone: +1-608-524-0625

Glossary

¼-inch jack

Common analog audio connector used as both an audio input and output. When a ¼-inch jack is described as TRS (tip-ring-sleeve) it can be wired as either a balanced connection or as a two-channel connection. ¼-inch headphone jacks are typically wired as TRS stereo jacks.

3.5 mm jack

Common small-format audio connector. Often used for headphones and -10 dBV signals for portable audio devices.

Advanced Audio Coding (AAC)

An audio coding standard for lossy digital audio compression. Designed to be the successor of the MP3 format, AAC generally achieves better sound quality than MP3 at the same bit rate.

AES3

A standard for the exchange of digital audio signals between professional audio devices. An AES3 signal can carry two channels of PCM audio over balanced, 110 ohm interconnections. AES3 is most commonly interconnected with XLR-3 cables.

AES42

A digital interface protocol for microphones and microphone inputs. Microphones conforming to this standard directly output digital audio through an XLR or XLD male connector, rather than producing an analog output. AES42 microphones require powering.

Attenuation

A reduction in the level of an audio signal. Attenuation can be applied to both analog and digital signals. A fader is used primarily to attenuate signals, though a small amount of positive gain is often available on a fader.

bEXT chunk

Broadcast WAV extension data added to the audio data in a WAV file. The bEXT chunk includes timecode and user bit data. For systems that do not recognize the bEXT chunk this additional information is ignored.

Bit depth

When converting between analog and PCM digital audio the amplitude of an analog signal is measured in finite steps, measured in bits. Higher bit rates result in greater resolution of amplitudes, resulting in higher dynamic range. 24-bit audio, with a theoretical maximum dynamic range of 144 dB, is the standard bit depth used throughout the audio chain for production. 32-bit floating point has a theoretical dynamic range of ~1500 dB and can capture sound levels exceeding 0 dBFS.

Broadcast WAV, BWAV

Broadcast WAV files are WAV files with additional, non-audio data, such as bEXT chunk data. Broadcast WAV files offer timecode support.

Bus

An audio path that is the destination of one or multiple (mixed) channels. A bus is typically routed to an output, a record track, or both.

Camera return

An audio input on a mixer designed to receive the output, typically the headphone output, of a camera. Camera return inputs allow the user to monitor the level and quality of the signal received at the camera. On the 833 the Aux In can be used as a source for any channel.

CEDAR sdnx™

CEDAR Audio Ltd.'s highly-regarded noise suppression technology is available as an optional paid plugin from store.sounddevices.com. Use CEDAR sdnx to reduce unwanted background noises so you can better capture dialog. CEDAR sdnx has near-zero latency and one simple control for adjusting the amount of suppression. Up to 8 instances of CEDAR sdnx are available per mixer-recorder/device. These instances can run on any combination of isolated channels (excluding 17-32 on Scorpio) or bus.

Channel

A "slot" of a mixer that is controllable and routable. A given input feeds the channel and the channel's settings process and route the audio as required. It can also be thought of as the path its selected input signal takes on its way to its record track, a bus, or an output.

Channel grouping

With the 833 all of the 8 channels can be grouped together so that their faders, record arming state mute states can be controlled together. Channel grouping can be used as an alternative to sending channels to a bus.

Circled take

An identifying character, the @ symbol, which is placed in the file name to highlight a take. Circled takes can either be used to identify good takes or to identify tracks or takes that will be ignored

Com return

A dedicated audio input designed to receive signals from a PL, or private line communications circuit. The com return on the 833 can be routed to an output or a bus.

Com send

A dedicated output designed to send signal to a PL (private line, talkback) communications circuit. The com send is toggled by a front panel switch.

dBFS

A measurement of the signal level of a digital signal in dB increments, dB relative to full scale signal. The maximum signal in dBFS is 0 dBFS, with signals expressed with a negative sign. dBFS signal strength is an internal measurement and does not correspond to analog signals unless the relationship between analog signal and digital signal is known.

Delay (channel)

Time delay that can be applied to an individual channel. Channel delay, typically set in milliseconds, is often used to compensate for different acoustical or electrical arrival times of signals between channels.

Dugan Automix

An automatic mixing algorithm invented by Dan Dugan which when used across multiple microphone inputs for speech, makes decisions about which inputs should be given priority due to speech being present vs. open, but unused inputs. This allows for greatly improved audio by turning down the inputs that aren't used and automatically turning up the inputs that are being used in real-time and transparently

exFAT

A storage volume format that can be read and written from current versions of MacOS and Windows. exFAT supports volume sizes up to 128 PB (gigantic), and individual files can have a maximum size of 16 EB (even more gigantic, bigger than the maximum volume size).

Fader

A physical control on a mixing console, either a rotary or sliding potentiometer, that controls the level of a channel to a bus. Most faders have more attenuation than gain available and a unity gain position where the input trim level established the level to the bus.

False take

A recorded take that was either erroneously recorded, or a take that needs to be repeated. It can be labeled after recording. An identified false take is moved to the trash bin and the auto-incrementing take number is reset to the value prior to the false take.

file list

Every file recorded by a recorder is visible in the file list. It can be viewed either on a recorder or from a computer when the recording volume is mounted. The file list shows all the individual files recorded by a recorder.

Frame rate

The rate at which video or motion picture images are recorded or played back, measured in frames-per second (FPS). All audio and video devices must be running at the same frame rate to keep audio and video synchronized. Timecode frame rates are either an integer or non-integer value. Integer values include 24, 25, and 30 FPS. Non-integer frame rates include 23.976 and 29.97, and 29.97 drop FPS.

Frequency

The period at which a wave oscillates, measured in hertz (Hz). Frequencies audible to humans range from 20 Hz for very low frequency signals to 20 kHz for very high frequency signals.

Gain

An increase (or decrease with negative gain) in the level of an audio signal. Gain can be applied in several locations, to both analog and digital signals. In a field mixer the microphone preamplifier provides a substantial amount of gain at the trim to raise the low level microphone signal to a usable signal in the mixer. Gain is also available at the fader. Gain of digital signals or line level analog signals is often limited. Unity gain is gain stage that neither adds or subtracts level from a signal.

Headphone monitor

Often a separate bus with a dedicated headphone volume control, the headphone monitor typically is normalled to the main left/right output bus of a mixer. Headphone sources can often be selected among soloed tracks or buses. In some products complex headphone monitoring of MS Stereo, LR stereo, and ambisonic sources is available.

High pass filter (audio)

Also referred to as a low-cut filter, this circuit reduces the amount of low frequency content in an audio signal. A HPF is particularly useful when recording speech since the human voice does not generate appreciable energy at low frequencies. The HPF reduces non-speech signals such as environmental noise, wind noise, and microphone handling noise, improving the intelligibility of speech and reducing low frequencies from overloading the input. The high pass filter is placed in the circuit close to the microphone preamplifier.

High pass filters are often frequency selectable, ranging from 20 Hz to 200 Hz. HPF also have a slope, generally from 3 dB/octave to 18 dB/octave. Greater/steeper slopes offer more attenuation of frequencies just below the set filter frequency.

Input

The physical connection and associated signal type from external sources connected to a device. Inputs can include microphone inputs on XLR connectors or USB audio inputs from a computer. Depending on the architecture of the mixing console its inputs may be hardwired to channels or channels can be selected from different inputs.

Input limiter

A limiter circuit reduces the peak signal levels of audio, generally to prevent signal overload. Analog inputs have a maximum input signal level that can be reached before overload/distortion is introduced. Setting the input gain correctly so that input signals do not reach this maximum level prevents most overload conditions. In the presence of very high, unexpected signals an input limiter changes the gain of the incoming signal and prevents it from overloading. Input limiters are sometimes compressor-type circuits with a ratio of infinity:1, meaning that any increase to the input signal into the limiter at the limiter threshold does not increase the output signal of the limiter.

Several parameters may be available in a limiter, including knee, ratio, release, and threshold.

Isolated track

A recorded track of an individual microphone or sound source. "Iso" recordings allow for post-record mixing of individual sound elements.

iXML

An extensible data schema for audio and related metadata stored in broadcast WAV files. Manufacturer-specific data generated during recording is stored in iXML.

Line level

An analog audio signal used to interconnect audio equipment. Line level may be balanced or unbalanced, referenced to +4 dBu or -10 dBV, professional or consumer respectively.

Low cut filter

See high pass filter.

Microphone level

The audio signal generated by a microphone. Mic level signals are very low level, requiring a microphone preamplifier to bring them to usable, line levels. Interconnects with microphone level signals can be subject to noise and interference.

Mid-side linking (inputs)

When mid-side (MS) stereo inputs are used and the inputs are set to MS linking and MS decoder is activated for those inputs. This yields a stereo signal with one fader controlling overall input level and control for the "width", or amount of the side signal added. With an MS matrix at the input, the signal is sent to an output bus as left/right stereo. Mixers with MS matrices often allow for discrete mid and side signal recording. In that case the MS decoder can be activated at the headphone selection to monitor left/right stereo.

MixAssist™

An exclusive Sound Devices automatic mixing algorithm which when used across multiple microphone inputs for speech, makes decisions about which inputs should be given priority due to speech being present vs. open, but unused inputs. This allows for greatly improved audio by turning down the inputs that aren't used and automatically turning up the inputs that are being used in real-time and transparently.

Mix track

A recorded track that is a sum of multiple tracks. In production sound the mix track is often a single summed track of all production dialog elements. Mix tracks can also be sub-mixes of like microphones, such as a sub mix of just lavalier microphones or just boom microphones.

Monophonic WAV

A WAV file that is comprised of a single track of audio. When recording multi-track audio with monophonic WAV files each track is recorded to its own WAV file, with a file name indicating the track number. All associated monophonic files that are part of a multi-track recording will be identical lengths.

Mute

A mute control is a convenient on/off switch for a channel and an easy way to remove a channel from appearing in downstream buses. Mute an input or channel does not change levels or settings; when channels are muted and unmuted, their settings remain.

Notes (metadata)

A metadata field that is saved along with audio data in a recorded sound file, useful for sound report generation. Some workstation software recognizes the notes field and presents it when viewing the sound file.

NoiseAssist™

An exclusive Sound Devices noise suppression algorithm which is available as an optional paid plugin from store.sounddevices.com. Use NoiseAssist to suppress background noises such as traffic, generators, HVAC noise, and more. The plugin continuously monitors background noise to give you clean audio for the entire take. Up to eight instances of NoiseAssist can run on any combination of isolated channels (excluding 17-32 on Scorpio), bus L, or bus R.

NP-1(A) battery

A specific class of battery, originally developed by Sony. There are multiple chemistries in this class including lithium-ion and nickel-cadmium.

Output

The physical connection and associated signal type sent from a device. Outputs can be source from inputs, buses, record tracks, and other auxiliary signals.

Output auto-mute

When set, an output signal is muted when recording is stopped, restricting program audio from being sent to listeners "between takes".

Output delay

A digital delay applied at the output. Signal delay is often set at an output to compensate for the delay introduced by digital imaging systems so that picture and sound remain in correct "lip sync". Output delay is set in either frames or milliseconds.

Pan

When a channel is routed to a stereo-linked bus the level it appears at each bus is adjusted by a pan control. A channel with its pan control "straight up the center", or "centered" sends signal at the same level to each bus. A channel that is panned left or right sends the signal to the left or right bus, respectively.

PFL, pre-fade listen

When an input or channel is selected for monitoring/solo with a PFL, the channel is routed to the headphone output before the channel fader so that the fader position has no effect on the headphone level. Trim/gain changes to the input will change the headphone output.

Phantom power

Condenser (capacitor) microphones require power for operation. They use power to charge the diaphragm backplate (for true condensers) and power the impedance convert located adjacent to the microphone capsule. Phantom power is the method for microphone inputs to supply DC power to the microphone through the same connection used for the audio signals from the microphone.

Phantom power provides a positive voltage, typically between 11-52 VDC, with 48 V being the most common, on both pin-2 and pin-3 with pin-1 used as ground. The DC voltage appears as a common-mode signal on the balanced connection and is rejected by the connection's differential amplifier. Phantom power has no effect on dynamic microphones.

Phase

The relationship one audio signal has in time with respect to another audio signal, defined in degrees of phase. When audio signals are generated at identical times, they are "in phase" with each other. When one audio signal is time-delayed with respect to another the signals are "out of phase". Differing phase relationships can be introduced several ways, including when microphones are placed at varying distances from a sound source, or electrical/digital delay is introduced to one signal with respect to another.

Phrase

A pre-set text string which can be used to quickly fill out the notes field.

Pre-fader routing

The signal from a channel is routed to a bus before the fader in the signal path. The input trim, if available, controls the channel level sent to the bus. Isolated tracks are typically recorded pre-fader so that any level changes made to the faders don't affect the recorded signal.

Pre-roll

A continuous buffer that is always writing to memory offering a recording that begins prior to when the record button is activated. Pre-roll is set in seconds, and the recording begins the set number of seconds prior to the button being pressed. This is helpful in applications where an operator missed a cue to begin recording.

Polarity (audio)

The direction of the current flow of an audio signal is defined as polarity. The polarity of a signal can reversed when a balanced audio signal connection has its pin-2 and pin-3 connections reversed. Single-ended signals can have their polarity reversed when going through an "inverting" gain stage. It is best practice to have all incoming and outgoing signals with the same polarity relationship.

Polyphonic WAV

An individual WAV file that contains multiple audio tracks. When recording multi-track audio with polyphonic WAV files all recorded tracks are contained within a single WAV file.

Post-fader routing (after fade routing, AFL)

The signal from a channel is routed to a bus after the fader in the signal path. The fader controls the level of the channel at the bus. Channels sent to a master bus, such as the left/right bus, are typically sent post-fader.

Post-roll

An extra period of time that is appended to the end of a recording when stop is pressed. If record is pressed during this period of time, recording will resume within the same file with no audio lost. This is particularly useful should a Director call 'cut' prematurely or accidentally.

Project

An option available for file organization on Sound Devices recorders. Projects are the highest level of file folder organization. The project folder can contain sub-folders of scene files or recorded files directly.

Record bell

A tone generated in headphones to alert the listener that recording has started. The bell is also produced when recording has ended with the stop button, when the recording volume is full, or when power is in a critical state.

Record Folder

The destination folder for recorded takes. The 8-Series supports a three-tier folder hierarchy allowing for flexibility in organizing recordings.

Sampling rate

When converting between analog and PCM digital audio the analog signal is measured (sampled) in unique steps at a data rate specified in kHz. Higher sampling rates allow for representing higher frequency analog audio. 48 kHz is the standard sampling rate for production, worldwide. Higher sampling rates including 96 kHz and 192 kHz are used for high-precision applications where the representation of audio above 20 kHz is required. A general rule is that the maximum analog audio frequency is $\frac{1}{2}$ the sampling rate.

Scene

On Sound Devices recorders the scene becomes part of the file name for a take. Scene names can be pre-loaded to quickly change between scenes.

Slate microphone

A microphone, built-in or external microphone, on an audio mixer used to notate takes or communicate with sound team members by the mixer's user speaking into the microphone. Slate microphones are often routable to buses or tracks.

Smart Battery

A lithium-ion rechargeable battery with integrated telemetry indicating battery condition, run time and other useful data.

Stereo linking (inputs)

When active for stereo sources such as stereo microphones, linked inputs are hard panned to the left and right bus. Controls including gain (trim), fader, high pass filter, delay, limiter, mute, and routing are controlled together.

Solo

A control on a mixer to route a channel to headphones while muting all others. Solo and PFL are related controls and in many consoles are the same. Solo circuits can be exclusive—only one channel is sent to headphones at a time—or non-exclusive—any number of channels can be sent to the solo circuit and appear in headphones.

SuperSlot™

SuperSlot™ is an electro-mechanical connection protocol, developed by Sound Devices, to simplify the interconnection of wireless audio transmitters and receivers with audio mixers and cameras. SuperSlot provides, power, audio, and control signals over a single multi-pin connection. SuperSlot-compatible products will be offered by multiple manufacturers, including wireless system manufacturers, camera manufacturers, and audio mixer manufacturers.

TA-type connector (TA3, TA4,TA5)

Miniature XLR-type, locking connectors. TA3 connectors are used by Sound Devices for various inputs, outputs, and as balanced and unbalanced connections. TA4 connectors are used by Sound Devices for DC power connections to the 833 mixer-recorder. TA4 is also used for audio connections from lavalier microphones to some wireless transmitters. TA5 connectors are used for the 833 headset input. TA6 connectors are presently not used by Sound Devices though they are used for audio connections by other manufacturers.

Take

A recorded take is an individual recorded file (or files when recording monophonic WAV files) generated by a recorder. Take numbers are auto-incrementing. Take numbers are added to the end of the file name.

Take list

Separate from a file list, a take list consolidates related files such as a group of monophonic WAV files generated by a single take and presents them as a single take.

Test tone

See tone oscillator.

Timecode

A numerical clock value expressed in hours:minutes:seconds:frames, i.e. 04:59:39:05, used to synchronize cameras, video decks, and audio recorders. Timecode requires clocks on devices to be synchronized, either through a wired or wireless connection between devices, or through a process called "jam sync" where each device, which requires a high-precision clock, runs independently after their clocks are synchronized.

Timecode mode

Sound Devices recorders offer multiple timecode modes. Different modes correspond to different timecode workflows. Common modes available in Sound Devices recorders include:

record run - timecode advances only when recording is engaged

free run - timecode run continuously, typically with the start of production being at 0 hour

24 hour - similar to free run except the start time corresponds to time-of-day

ext TC - the recorder applies the value of an external timecode source.

Tone oscillator

A sound generator producing a sine wave tone at a given frequency at a given output level. With its known output level tone oscillators are helpful to set gain structure between audio equipment.

Track

A single recorded audio signal. Common recorded tracks are the main left/right master audio bus and isolated (iso) channel recordings. Iso tracks are typically identified by the channel of the same number, e.g. channel 1 is sent to track 1, channel 2 is sent to track 2, etc.

Track arm

Tracks that are active and ready for recording are said to be “armed”. When recording begins all armed tracks begin recording. Depending on the production it may be advantageous to arm and disarm tracks, especially to disarm unused tracks.

Track name

Individual tracks of a multi-track recording can be named to indicate microphone type or character name.

Trim

Also defined in mixers as “gain”, the trim adjustment is the first stage of gain of a microphone or line level input. Typical microphone trim values range from 10 dB to 50 dB, depending on microphone sensitivity and volume of the sound source.

User bits

Static, numeric data that is available as part of a timecode signal. User bits are often used to indicate the date of a file. User bits are four sets of two-digit hexadecimal numbers from 00 to ff.

WAV File

A universal, well-supported file type for sound file recordings. WAV files can contain one or more (up to 65,535) tracks of PCM audio data at any sampling rate and bit depth. A standard WAV file is limited to a maximum file size of 4 GB. Sound Devices uses the .WAV extension for recorded files, including for files with Broadcast WAV metadata.

WAV RF64

An extension of the WAV file type that supports file sizes larger than 4 GB. When recording high track count, high sampling rate polyphonic WAV files, the 4 GB size limitation of WAV can be reached quickly. RF64 files larger than 4 GB require recording to a volume type that can support file sizes larger than 4 GB.

Word clock

A reference signal used to synchronize the sampling rate of multiple digital devices.

XLR female

Industry-standard 3-pin locking audio connector for microphone and line-level sources. Predominantly used as an input. Also shown as XLR-F.

XLR male

Industry-standard 3-pin locking audio connector for microphone and line-level sources. Predominantly used as an output. Also shown as XLR-M.

This product incorporates software subject to the BSD license:

Copyright 2001-2010 Georges Menie (www.menie.org)

All rights reserved. Redistribution and use in source and binary forms, with or without modification, are permitted provided that the following conditions are met

* Redistributions of source code must retain the above copyright notice, this list of conditions and the following disclaimer.

* Redistributions in binary form must reproduce the above copyright notice, this list of conditions and the following disclaimer in the documentation and/or other materials provided with the distribution.

* Neither the name of the University of California, Berkeley nor the names of its contributors may be used to endorse or promote products derived from this software without specific prior written permission.

* THIS SOFTWARE IS PROVIDED BY THE REGENTS AND CONTRIBUTORS ``AS IS'' AND ANY EXPRESS OR IMPLIED WARRANTIES, INCLUDING, BUT NOT LIMITED TO, THE IMPLIED WARRANTIES OF MERCHANTABILITY AND FITNESS FOR A PARTICULAR PURPOSE ARE DISCLAIMED. IN NO EVENT SHALL THE REGENTS AND CONTRIBUTORS BE LIABLE FOR ANY DIRECT, INDIRECT, INCIDENTAL, SPECIAL, EXEMPLARY, OR CONSEQUENTIAL DAMAGES (INCLUDING, BUT NOT LIMITED TO, PROCUREMENT OF SUBSTITUTE GOODS OR SERVICES; LOSS OF USE, DATA, OR PROFITS; OR BUSINESS INTERRUPTION) HOWEVER CAUSED AND ON ANY THEORY OF LIABILITY, WHETHER IN CONTRACT, STRICT LIABILITY, OR TORT (INCLUDING NEGLIGENCE OR OTHERWISE) ARISING IN ANY WAY OUT OF THE USE OF THIS SOFTWARE, EVEN IF ADVISED OF THE POSSIBILITY OF SUCH DAMAGE.



Post Office Box 576
E7556 State Rd. 23 and 33
Reedsburg, Wisconsin 53959 USA

support@sounddevices.com

+1608.524.0625 main
800.505.0625 toll free (U.S. only)

www.sounddevices.com