

CONTOUR CT212

HORN-LOADED POINT SOURCE



FEATURES

- 3-Way Enclosure
- Freestanding, Wall, or Ceiling Deployment
- High SPL (max 145 dB @ 1 m)
- Medium-long Throw
- 100° x 50° coverage down to 200 Hz
- IP55 + Salt Water Resistant

APPLICATIONS

- Restaurants
- Lounges
- Houses of Worship
- Theaters
- Entertainment Venues
- Outdoor Systems

DESCRIPTION

The Contour CT212 is a horn-loaded 3-way passive loudspeaker capable of delivering a maximum SPL of 145 dB. This is a powerful speaker that sounds full and present while still sounding intimate at lower volumes. This horn-loaded point-source enclosure combines two 12" low-frequency drivers with a coaxial mid-high compression driver, the latter using a 4" plus a 2.5" voice coil. The CT212 delivers a controlled 100° x 50° dispersion pattern, maintaining constant directivity down to 200 Hz, as well as a bass response down to 55 Hz. It is a long-throw point-source that maintains its directivity in the far field.

This loudspeaker is useful for medium to large scale installations and live production audio. Various rigging options are available, including the Contour Rigging System, which is applicable to both the CT212 and the CT28. The CT212 is IP55 rated and salt water resistant, and stainless steel 316 accessories are also available.

SPECIFICATIONS

Audio Specifications

- Description:** Bi-amplified, 3-way, horn-loaded point source
- Bandwidth:** 55 Hz - 20 kHz (-6 dB preset dependent)
- Max SPL:** 145 dB @ 1 m with preset
- Power:** 3600 watts LF + 380 watts MHF (continuous), 1800 watts LF + 190 watts MHF (AES)
- Directivity:** 100° x 50°
- Elements:** (2) 12" low frequency drivers, (1) 4" + 2.5" coaxial mid-high compression driver
- Impedance:** 4 Ω LF + 16 Ω MHF
- Connectors:** (2) NL4 audio input and link

Mechanical Specifications

- IP Rating:** IP55 indoor/outdoor and salt water resistant
- Rigging:** (8) M5 points, (4) M6 points
- Weight:** 91 lbs / 41.6 kg
- Construction:** Finland birch plywood (phenolic resin), three coats of polyurea, matte salt and UV resistant coating, A4 (316) stainless steel and powder-coated steel hardware, 3D spacer mesh fabric
- Dimensions:** 20.6" (525 mm) x 18.1" (460 mm) x 30.8" (783 mm)
- Colors:** Stocking black and white, custom colors and fabrics available
- Accessories:** CT212 Fly Bar, CT212 Horizontal Mounting Bracket, CT212 Wall Bracket, CT212 Rigging System, Tube Mount, removable magnetic front grille [included]

DIRECTIVITY

Horizontal Polar Plot

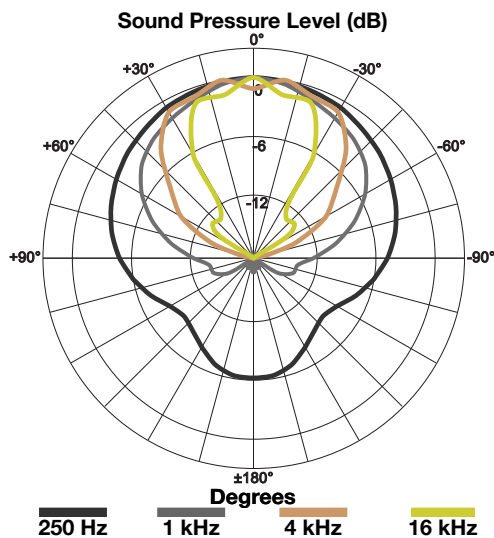

Vertical Polar Plot

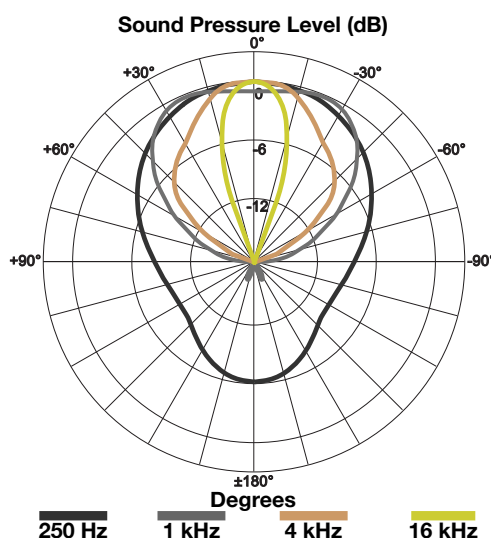

Horizontal

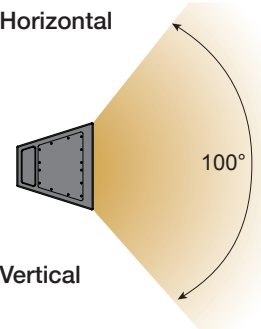

Vertical

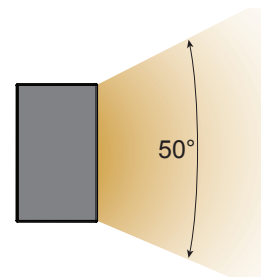

FREQUENCY RESPONSE

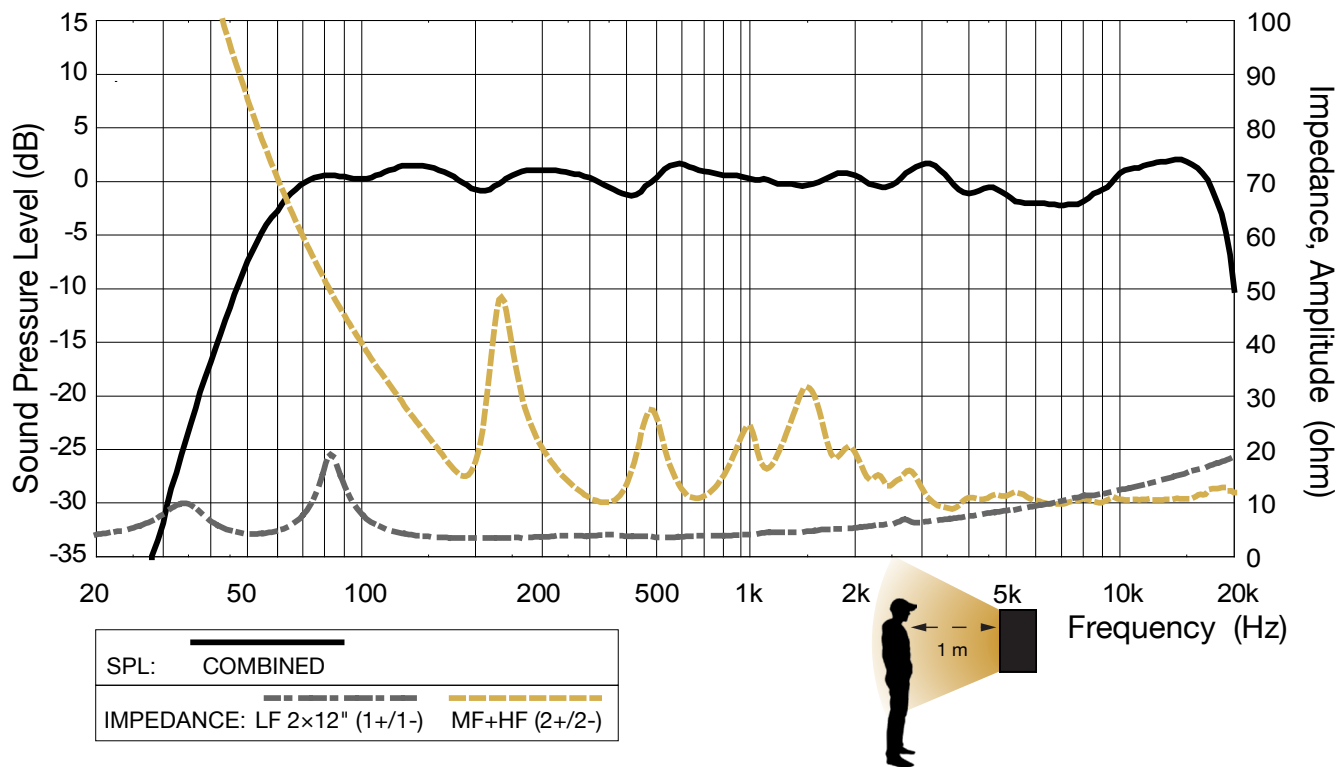

WIRING

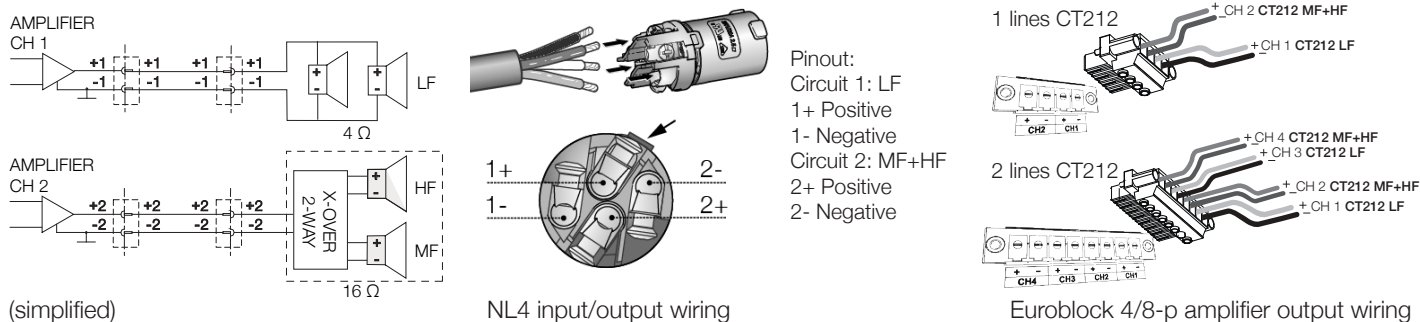

DIMENSIONS

RIGGING

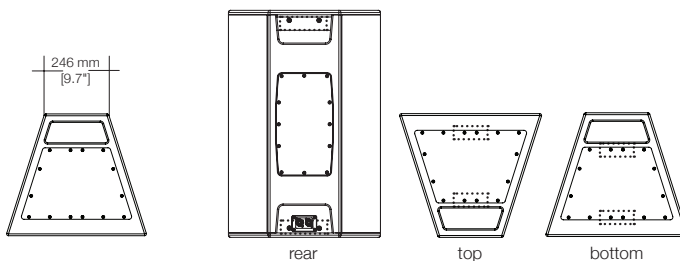
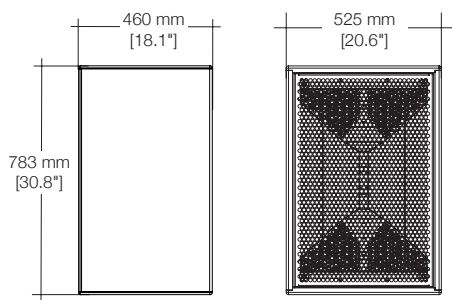

- (4) points M6
 (8) points M5
 • Rear: (4) points M6
 • Top: (4) points M5
 • Bottom: (4) points M5

ACCESSORIES



Contact

For more product or service information please contact the 1 SOUND headquarters.

1 SOUND, Manufacturer
 USA Distributor
 34 Apple Street
 Tinton Falls, NJ 07724

tel. +1-732-798-9900
 sales@1-sound.com

Warranty

All manufactured 1 SOUND products are warranted to be free from defects in materials or workmanship for a period of 3 years from original purchase. If there is specific hardware or grilles you might want replaced or any repairs needed please contact your region's authorized 1 SOUND distributor.

